



**NATIONAL COMMISSION FOR THE  
CERTIFICATION OF CRANE OPERATORS (NCCCO)**

**ARTICULATING CRANE  
REFERENCE MANUAL**

## **HOLD HARMLESS/RELEASE AGREEMENT**

The user of this publication for and in consideration of the assistance, cooperation, and information provided by the National Commission for the Certification of Crane Operators (NCCCO) in this publication, *Articulating Crane Reference Manual*, the receipt of which is acknowledged, does hereby and for all future time release and hold harmless from any liability, and forever discharge for itself, its administrators and assigns the said NCCCO from all and any manner of action or demands whatsoever in law, in admiralty, or in equity, which against NCCCO anyone ever had, now have, or which shall later be claimed. This Agreement relates specifically to any cause of action arising out of the publication, information provided, subsequent conduct, and any use of the information provided in this publication and related uses or demonstrations of skills, methods, and techniques cited in the publication. This mutually beneficial release and hold-harmless agreement may not be changed orally and exists in perpetuity. This publication is issued solely as a public service to improve the lifting industry and promote public safety.

## **NO WARRANTY**

Information and materials provided in this *Articulating Crane Reference Manual* are provided “as is” without warranty of any kind, either express or implied, including without limitation warranties of merchantability, fitness for a particular purpose, and non-infringement. NCCCO specifically does not make any warranties or representations as to the accuracy or completeness of any such information and materials. Under no circumstances shall NCCCO be liable for any loss, damage, liability, or expense incurred or suffered which is claimed to have resulted from use of this publication, including without limitation, any fault, error, omission, interruption, or delay with respect thereto. Use of this publication is at user’s sole risk. Under no circumstances, including, but not limited to, negligence, shall NCCCO be liable for any direct, indirect, incidental, special, or consequential damages, even if NCCCO has been advised of the possibility of such damages.

Copyright 2009–2016 by the National Commission for the Certification of Crane Operators. All rights reserved. No part of this book may be reproduced or transmitted in any form or by any means, electronic or mechanical, including photocopying, recording, or by any information storage and retrieval system, without prior written permission from the publisher. For information, contact the publisher, the National Commission for the Certification of Crane Operators, at [info@nccco.org](mailto:info@nccco.org).



## Preface

Articulating crane operators are unique among crane operators in that they are often responsible for, among other things, pre-operation inspection of the crane and truck; securing the load to the truck; driving the crane truck to the job site; identifying any hazards; properly setting up the truck and crane to make the lift; planning the lift; selecting, inspecting, and utilizing the proper rigging; attaching the rigging to the load and hook; and, finally, making the lift safely.

This *Articulating Crane Reference Manual* provides technical information, specifications, load charts, and general information regarding articulating cranes. This manual is to be used in conjunction with the exam content outline and the exam reference list found in the *Articulating Crane Operator Candidate Handbook* to prepare for the Written Examination for the National Commission for the Certification of Crane Operators (NCCCO) Articulating Crane Operator certification.

The information contained herein is not specific to any single manufacturer. Further, none of the information is to be used for the actual use, operation, or maintenance of any articulating crane. That information must be obtained from the operator's manual specific to the crane involved.

***This reference guide is not intended to supersede or replace manufacturers' operator's manuals, OSHA 29 CFR 1926 Subpart CC, nor the current ASME B30.22 standard for articulating boom cranes.***

The material contained herein is not to be used for any other purpose than as reference material in association with preparing for the NCCCO certification exams. No part of this manual is to be copied or used in any other manner.

## CREDITS

NCCCO deeply appreciates the work and contributions of the following individuals and organizations, all of whom have assisted in developing this reference manual:

### Articulating Crane Task Force Members

Tim Arkilander, Cargotec USA Inc. HIAB, *Task Force Chairman*

Eric Andrews, Gypsum Management & Supply

Udo Beyersdorff, North American Lifting Equipment (Effer USA)

Bo Collier, Crane Tech

James Darr, Iowa Mold Tooling Co.

Tony Dotto, Crane Tech

Bernie Faloney, Fascan International

**John Field, Iowa Mold Tooling Co.\***

Robert Fischer, Fischer Crane Co.

Stefano Ghesini, PM North America LLC

Ted Gill, L&W Supply Corp.

**Ed Hatcher, Cargotec USA Inc. HIAB\***

Pinchas Leitner, Lifting Solutions

**Thomas Lyon, Trench Plate Rental Co.\***

**Harry Newmann, V&H Trucks Inc.\***

**Ron Overton, Overton Safety Training\***

Peter Sharkey, Bradco Supply Co.

Kenneth Shinn, KJ Shinn

Sid Shreiner, Manitowoc Crane Group

Dave Taff, Ruco Equipment Co.

Walter Timm, Palfinger North America

\*This subgroup of Articulating Crane Task Force members deserves special recognition for providing the foundation for this reference manual.

NCCCO also appreciates contributions from the various organizations that provided material and resources—including the members of the Articulating Crane Council of North America (ACCNA)—and thanks them for their continued support of crane operator safety.



**ACCNA**  
AN INDUSTRY DIVISION OF THE  
**National Truck Equipment Association**



# Table of Contents

<b>Chapter 1: Articulating Crane Terminology and Types .....</b>	<b>1</b>
1.1 Terminology .....	1
1.2 Types of articulating cranes.....	4
<b>Chapter 2: Safety Precautions and Warnings.....</b>	<b>7</b>
2.1 General safety precautions .....	7
2.2 Articulating Crane Council of North America warning decals and locations.....	7
<b>Chapter 3: Control Systems .....</b>	<b>13</b>
3.1 General precautions.....	13
3.2 Manual control station.....	13
3.3 Cable and radio remote controls.....	14
3.4 Top seat control station.....	14
<b>Chapter 4: Ancillary Attachments .....</b>	<b>15</b>
4.1 General precautions.....	15
<b>Chapter 5: Articulating Boom Loader and Fork Assembly .....</b>	<b>17</b>
5.1 General precautions.....	17
5.2 Safety precautions .....	17
<b>Chapter 6: Load Charts .....</b>	<b>19</b>
6.1 General precautions.....	19
6.2 Types of load charts .....	19
6.3 Reading load charts .....	20
6.4 Charts reflecting stabilizer deployment.....	20
6.5 Work area charts (lifting quadrants).....	20
6.6 Charts reflecting manual boom extensions .....	20
6.7 Capacity of rigging and attachments .....	21
6.8 Gross capacity vs. net capacity.....	21
<b>Chapter 7: Preparation for Crane Setup .....</b>	<b>23</b>
7.1 General precautions.....	23
7.2 Lift planning.....	23
7.3 Electrical hazards .....	23
7.4 Work site inspection.....	24
7.5 Operator’s control area(s) .....	25
7.6 Stabilizers.....	25
7.7 Leveling.....	26
7.8 Cribbing .....	26
7.9 Wind and weather.....	27
7.10 Lifting solution.....	28

<b>Chapter 8: Crane Operation</b> .....	<b>29</b>
8.1 General precautions.....	29
8.2 Operator responsibilities.....	31
8.3 Controlling load swing.....	31
8.4 Attaching or engaging the load.....	31
8.5 Handling the load.....	31
8.6 Safety and performance systems.....	32
8.7 Load movement.....	32
8.8 Load placement.....	32
8.9 Leaving the crane unattended (when leaving the work zone).....	33
8.10 Power failure.....	33
8.11 Ending operations.....	33
8.12 In transit (unloaded or loaded).....	33
8.13 Tag lines or guide ropes.....	33
8.14 Maintenance and service.....	34
<b>Chapter 9: Crane Inspection</b> .....	<b>35</b>
9.1 General precautions.....	35
9.2 Monthly inspections.....	35
9.3 Annual inspections.....	35
9.4 Cranes not in regular use.....	35
9.5 Articulating crane inspection checklist.....	35
<b>Chapter 10: Crane Communication and Signals</b> .....	<b>37</b>
10.1 General requirements.....	37
10.2 Standard voice signals.....	37
<b>Chapter 11: Load Hooks</b> .....	<b>39</b>
11.1 General precautions.....	39
11.2 Hook swivels.....	39
11.3 Latches.....	40
11.4 Load hook inspection.....	40
<b>Chapter 12: Rigging</b> .....	<b>41</b>
12.1 General precautions.....	41
12.2 Sling inspections.....	41
12.3 Basic hitches.....	42
<b>Chapter 13: Winch</b> .....	<b>43</b>
13.1 General information.....	43
13.2 Wire rope inspection.....	43
13.3 Safety precautions for wire ropes.....	44
13.4 Calculating working load limit/permissible line pull.....	44
13.5 Thimble attachment.....	45
13.6 Wedge socket attachment.....	45
<b>Appendix A: ACCNA Crane Inspection Checklist</b> .....	<b>49</b>
<b>Appendix B: Standard Hand Signals</b> .....	<b>54</b>
<b>Appendix C: NCCCO Load Charts</b> .....	<b>55</b>



## CHAPTER 1: **Articulating Crane Terminology and Types**

This chapter defines and illustrates various terms used to describe an articulating crane's components and functions. These terms often differ greatly from other types of cranes, so specific knowledge of these terms is invaluable when discussing various parts of the crane with manufacturers' parts and service personnel.

See also OSHA 1926.1401—Terminology and *OSHA Small Entity Compliance Guide for Final Rule for Cranes and Derricks in Construction* for additional terms that are applicable to articulating cranes.

### **1.1 Terminology**

**ancillary attachments:** Devices attached to the crane that perform functions other than lifting a load with a hook, such as forks, augers, grapples, or a digging bucket; see chapter 4

**anti-two block device:** A device that prevents two blocking from occurring if crane is used with load hoist mechanism

**articulating boom crane (ABC):** A crane with two or more boom sections that pivot (articulate) via hydraulic cylinder(s); also known as a *knuckleboom crane*; see Figure 1.1 (page 4)

**articulating boom crane with winch (ABW):** A crane with two or more boom sections that pivot (articulate) via hydraulic cylinder(s) and used with a load hoist mechanism; see Figure 1.3 (page 6)

**articulating boom loader (ABL):** A non-folding articulating crane with a permanently attached hydraulic fork restricted to loading and unloading materials from a truck; also known as a *drywall* or *material-handling crane*; see Figure 1.2 (page 5)

**base:** The main supporting structure of the crane that supports the stabilizer system and column (mast) to the vehicle

**boom extensions:** A telescopic (hydraulic or manual) boom section that extends the reach of the crane

**center of gravity:** The center of gravity of any object is the point in the object around which its weight is evenly distributed; if you could put a support under that point, you could balance the object on the support

**certified articulating crane operator:** A person possessing a currently valid articulating crane operator's certification

issued by a nationally accredited certifying agency (such as NCCCO)

**column (mast):** The vertical structure of the crane between the inner (main) boom and base

**crane rating:** A crane's gross lifting capacity established by the manufacturer

**designated person:** A person selected or assigned by the employer or employer's representative as being competent to perform specific duties

**electrical contact:** occurs when a person, object, or equipment makes contact or comes in close proximity with an energized conductor or equipment that allows the passage of current.

**extension cylinders:** The hydraulic cylinders used to extend and retract boom extensions

**fall zone:** means the area (including but not limited to the area directly beneath the load) in which it is reasonably foreseeable that partially or completely suspended materials could fall in the event of an accident

**fork assembly:** A device attached to the last extension of either an articulating boom crane or an articulating boom loader commonly used to engage loads of consistent characteristics (e.g., palletized loads or bundles of drywall or lumber)

**fork tines:** The component of a fork assembly that actually engages the load

**gross capacity:** The capacity listed on the crane's load chart

**hoist cable:** The wire rope used to lift loads via the winch and load hook

**hydraulic oil cooler:** A heat-exchanging device used during crane operation to reduce the temperature of the crane's hydraulic oil

**hydraulic tank:** The reservoir that holds the crane's hydraulic fluid

**inner (main) boom:** The boom section that connects the column to the outer boom

**inner (main) boom cylinder:** The hydraulic cylinder that raises and lowers the inner (main) boom

**jib:** A hydraulic boom section that articulates, extends, and attaches to the end of the outer boom's last extension

**link:** A mechanical device that changes the lifting curve of the crane

**load handling deductions:** The reduction of a crane's gross lifting capacity based on the sum of the additional weight of devices or attachments not already accounted for by the manufacturer (other than the weight of the load to be lifted)

**load hoist mechanism:** A hoist drum or rope reeving system used for lifting and lowering loads

**load-holding valve:** A valve that will hold a function in position and prevent movement in the event of hydraulic system failure

**load hook:** A device attached to the end of the crane's last extension (or hoisting line) and used for attaching loads to the crane

**load radius (ABC):** The horizontal distance from the center line of the crane's rotation to the center of gravity of the load

**load radius (ABL):** The horizontal distance from the center of the crane's rotation to the center of the rotator

**lower load block:** The assembly suspended by the hoisting rope, including the hook, swivel, sheaves, pins, and frame (if crane is used with load hoist mechanism)

**manual boom extension(s):** Manually extended and pinned boom section(s) that extend the crane's reach and are housed inside the last hydraulic boom extension

**net capacity:** The total weight a crane may lift after the load handling deductions have been subtracted from the gross capacity

**net load:** The weight of the load being hoisted, not including the weight of rigging or attachments

**operator's station (manual controls):** The position where the manual controls are located for operating the crane

**operator's station (top seat):** The elevated seat attached to the column where the operator can control the crane

**outer boom:** The boom section that connects to the inner (main) boom and houses extension section(s)

**outer boom cylinder:** The hydraulic cylinder that raises and lowers the outer boom

**overload protection (OLP):** A system that prevents lifting a load or increasing a load radius that exceeds the crane's capacity

**qualified person:** A person who, by possession of a recognized degree in an applicable field or a certificate of professional standing or by extensive knowledge, training, and experience, has successfully demonstrated the ability to solve or resolve problems relating to the subject matter and work

**reeving:** A manner of running additional parts of line from the boom tip to the lower load block with the purpose of increasing the lifting capacity of the hoist line

**relief valve:** A valve that governs hydraulic pressure

**remote crane controls:** Portable crane controls that allow the operator to operate a crane from remote locations in the general vicinity of the crane

**rope lay:** The axial distance along the rope in which one strand makes one complete turn around the rope

**rotation-resistant wire rope:** A wire consisting of an inner layer of strands laid in one direction covered by a layer of strands laid in the opposite direction; this has the effect of counteracting torque by reducing the tendency of the finished rope to rotate

**rotator:** A hydraulically controlled device that is pinned to the last boom extension and is used to control rotation of the load with respect to the longitudinal centerline of the boom

**sheave:** A grooved wheel or pulley over which the rope travels

**shock loading:** A condition that occurs when a moving load and/or crane component decelerates very rapidly, causing excessive inertial forces to be borne by the crane's structure

**side loading:** A force applied horizontally on the boom

**slew:** The rotation of the boom about the axis of the column (mast), normal to the base

**slewing system:** The mechanism that rotates the boom

**stability:** A condition where the forces to remain upright are greater than the forces to overturn

**stabilizer:** A component attached to the mounting base to increase the stability of the crane

**stabilizer beam:** The telescoping beam that holds the stabilizer leg

**stabilizer beam housing:** The portion of the base that holds the stabilizer beam

**stabilizer leg:** The hydraulic cylinder attached to the stabilizer beam used to stabilize the unit



**stabilizer pad:** A fixed or removable structural component of the stabilizer that distributes the applied force over a greater area

**step potential:** The voltage between the feet of a person standing near an energized grounded object; a person could be at risk of injury during a fault simply by standing near the grounding point

**stowed:** The position in which the crane is to be secured for transit

**tag line:** A line attached to the load to help control it during lifting

**three-point bridge:** The structural component of the crane's base that pivots, reducing stress on the mounting to the chassis

**touch potential:** The voltage between the energized object and the feet of a person in contact with the object (e.g., a crane that contacted an energized line would expose any person in contact with the crane or its uninsulated load line to a touch potential nearly equal to the full fault voltage)

**transit:** The moving or transporting of a crane from one job site to another

**two block–damage prevention feature:** A system that prevents damage to the hoist rope or crane machinery components caused by two blocking

**two blocking:** A condition where the lower load block or hook assembly comes in contact with the upper load block or boom point sheave assembly

**upper load block:** The assembly of sheaves, pins, and frame attached to the boom tip (if crane is used with load hoist mechanism)

**winch:** Power-driven drum(s) capable of lifting and lowering rated loads with a hoist cable

**work zone:** An area designated by means of recognized safety identifiers (such as cones, tape, or barriers) for the purpose of preventing non-authorized persons from entering

## 1.2 Types of articulating cranes

### 1.2.1 Articulating boom crane (ABC) and components

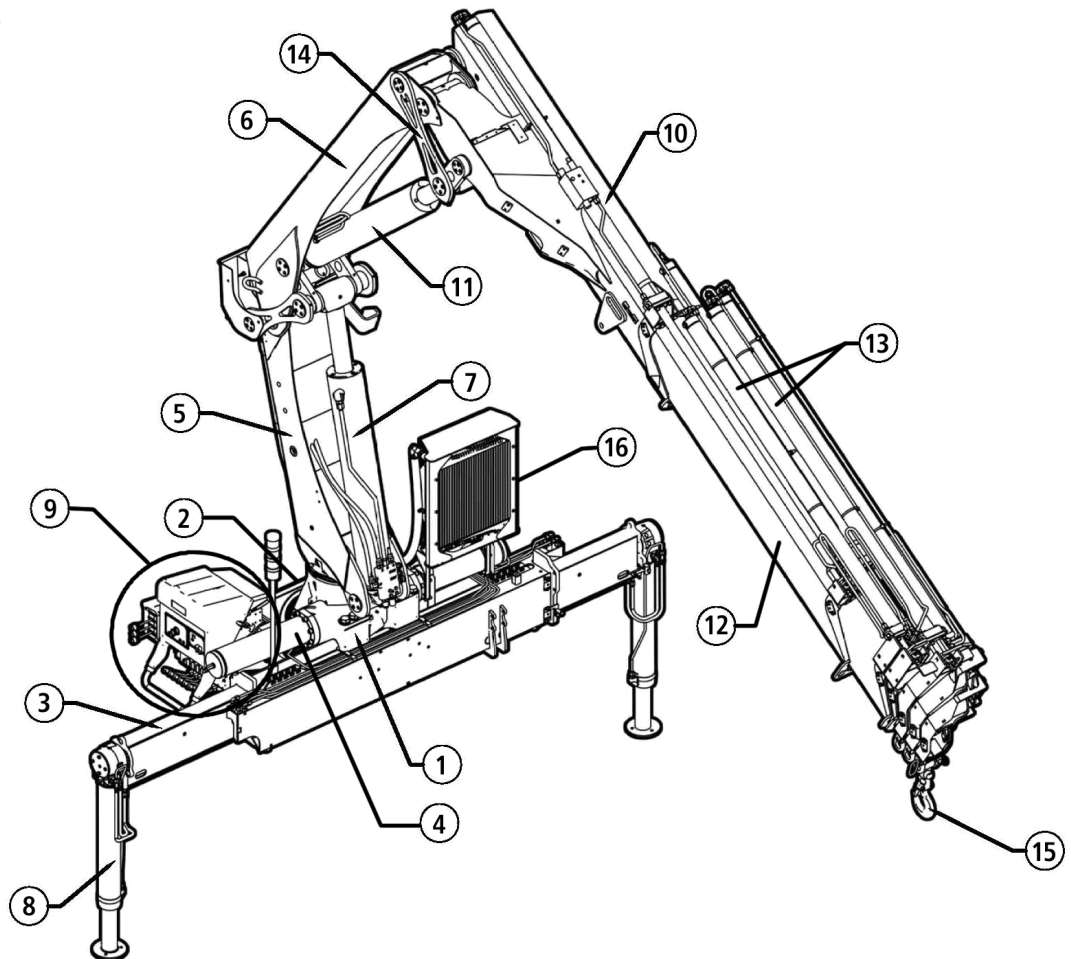

Figure 1.1: Articulating boom crane (ABC) and components

- |                               |                           |
|-------------------------------|---------------------------|
| 1. Base                       | 9. Manual control station |
| 2. Three-point bridge         | 10. Outer boom            |
| 3. Stabilizer beam            | 11. Outer boom cylinder   |
| 4. Slewing cylinder           | 12. Extensions            |
| 5. Column                     | 13. Extension cylinders   |
| 6. Inner (main) boom          | 14. Link(s)               |
| 7. Inner (main) boom cylinder | 15. Load hook             |
| 8. Stabilizer leg             | 16. Hydraulic oil cooler  |

**1.2.2 Articulating boom loader (ABL) and components**

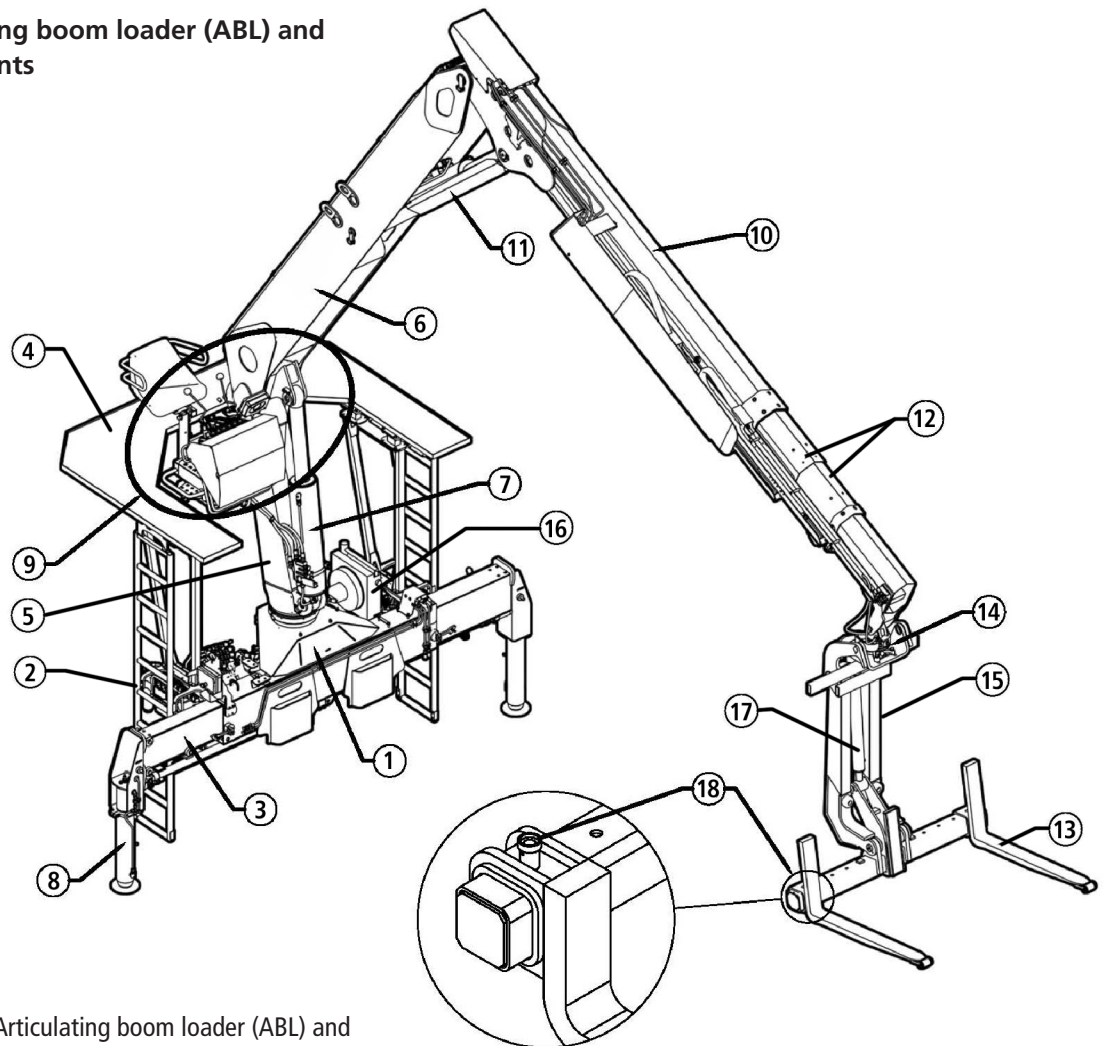

Figure 1.2: Articulating boom loader (ABL) and components

- |                                  |                          |
|----------------------------------|--------------------------|
| 1. Base                          | 10. Outer boom           |
| 2. Ladder                        | 11. Outer boom cylinder  |
| 3. Stabilizer beam               | 12. Extension booms      |
| 4. Platform                      | 13. Fork tine            |
| 5. Column                        | 14. Rotator              |
| 6. Inner (main) boom             | 15. Fork assembly        |
| 7. Inner (main) boom cylinder    | 16. Hydraulic oil cooler |
| 8. Stabilizer leg                | 17. Fork cylinder        |
| 9. Operator's station (top seat) | 18. Fork tine lock       |

### 1.2.3 Articulating boom crane with winch (ABW)

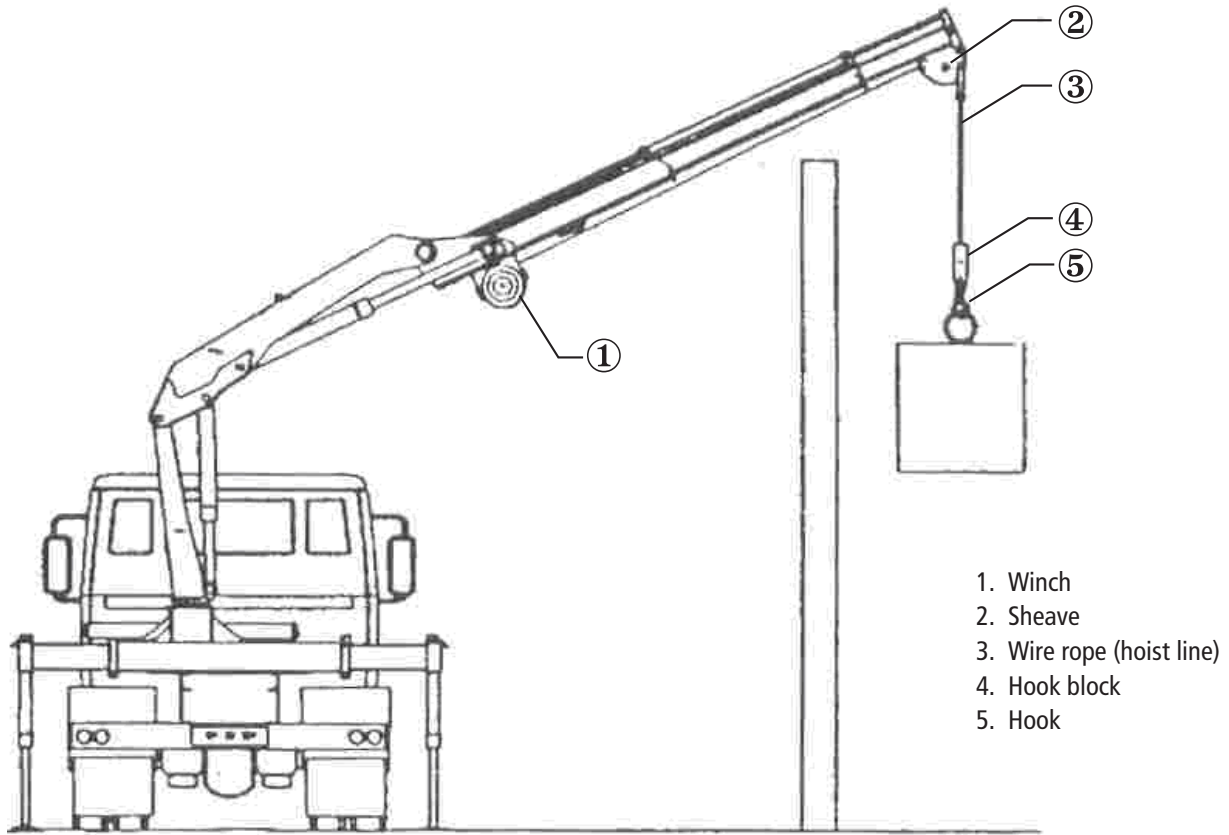

Figure 1.3: Articulating boom crane with winch (ABW)



## CHAPTER 2: Safety Precautions and Warnings

Nothing is more important than operating the crane in a safe manner. This chapter presents general rules, warnings, and standards regarding safety, including warning decals that were developed by the Articulating Crane Council of North America (ACCNA) to provide standardized graphic illustrations of various safety concerns. Additional safety information is also provided in other chapters throughout this reference manual.

### 2.1 General safety precautions

- Never tamper with the safety devices.
  - A fire extinguisher of type and rating specified by DOT or jurisdiction must be maintained on the crane or vehicle at all times.
  - Crane operators shall be trained in the correct use of fire extinguishers.
  - Do not refuel the vehicle while the engine is running.
  - Smoking or open flames are prohibited while refueling.
  - Do not use this equipment to transport people unless approved by the manufacturer.
  - Do not wear jewelry or loose-fitting garments that might become caught in moving parts.
  - Use personal protective equipment when necessary or required.
  - Respect all lockouts, tag-outs, or red-tags.
- When operating in an enclosed area (e.g., inside a building), ensure proper ventilation.
  - A high-voltage minimum-clearance sign must be visible to the operator while at the operator's station (Figure 2.1); this decal indicates the minimum 10 ft. clearance for lines under 50 kV as well as the minimum for higher voltages (as specified in OSHA 1926.1407 through 1926.1411).
  - Electrocutation hazard warning labels must be visible from all four sides of the carrier vehicle.
  - Decals must be legible; they must be replaced if they become illegible due to repainting, fading, or scratches.
  - Operators must be familiar with the location and purpose of required decals, as detailed below in section 2.2.

### 2.2 Articulating Crane Council of North America warning decals and locations

The table below shows standardized ACCNA decals and where they must be placed.

*Replace any missing or damaged decals.*

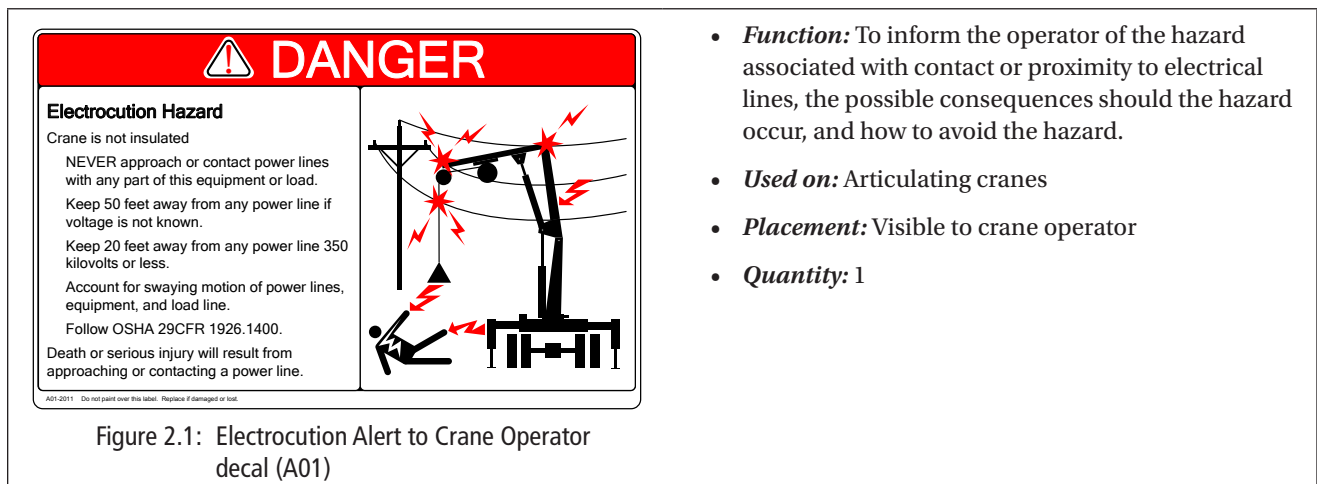

Figure 2.1: Electrocutation Alert to Crane Operator decal (A01)

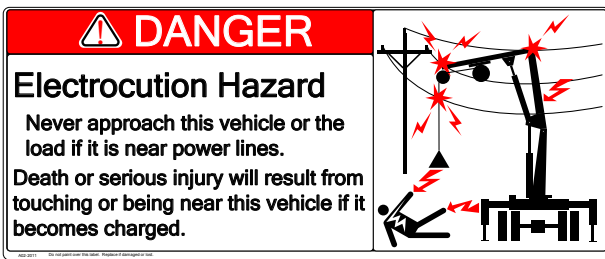

Figure 2.2: Electrocutation Alert to Pedestrians decal (A02)

- **Function:** To inform personnel in the work area of the hazard associated with contact or proximity to electrical lines, the possible consequences should the hazard occur, and how to avoid the hazard.
- **Used on:** Articulating cranes
- **Placement:** Visible to people approaching the crane
- **Quantity:** 4

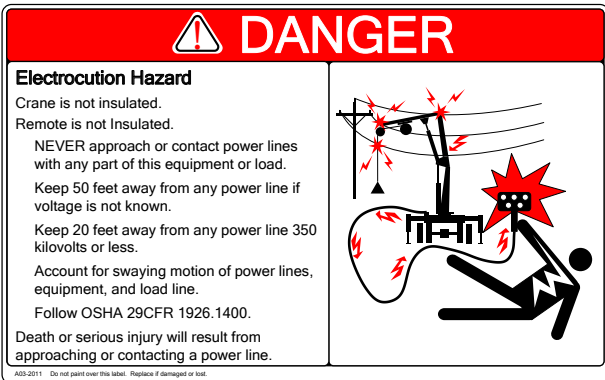

Figure 2.3: Electrocutation Alert to Crane Operator with Remote decal (A03)

- **Function:** To inform the operator of the lack of protection from electrocution afforded by the remote control, the possible consequences of the crane becoming electrically charged, and how to avoid the hazard.
- **Used on:** Articulating cranes
- **Placement:** Visible to crane operator
- **Quantity:** 1 if crane only equipped with remote control

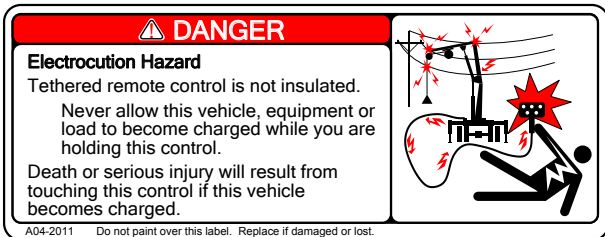

Figure 2.4: Electrocutation Alert to Crane Operator with Remote decal (A04)

- **Function:** To inform the operator of the lack of protection from electrocution afforded by the remote control, the possible consequences of the crane becoming electrically charged, and how to avoid the hazard.
- **Used on:** Remote controls on articulating cranes
- **Placement:** On the remote control unit
- **Quantity:** 1

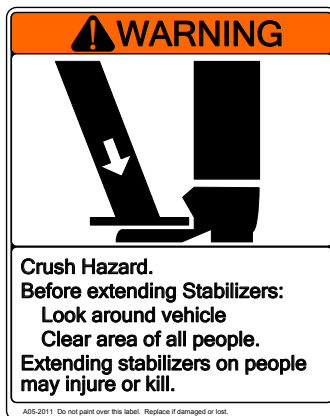

Figure 2.5: Stabilizer Crush decal (A05)

- **Function:** To inform the operator and other personnel in the work area of the hazard associated with the operation of stabilizers, the possible consequences should the hazard occur, and how to avoid the hazard.
- **Used on:** Articulating cranes
- **Placement:** Visible to person(s) standing near each stabilizer
- **Quantity:** 1 per stabilizer

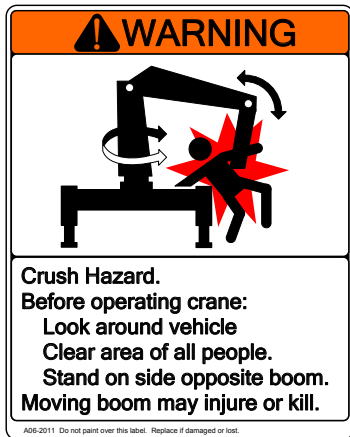

Figure 2.6: Crane Strike decal (A06)

- **Function:** To inform the operator and other personnel in the work area of the hazard associated with a moving boom especially while stowing and unfolding the crane, the possible consequences should the hazard occur, and how to avoid the hazard.
- **Used on:** Articulating cranes
- **Placement:** Visible to people standing near the crane
- **Quantity:** 1



Figure 2.7: Rotating Shaft Hazard decal (A07)

- **Function:** To inform personnel of the hazard associated with rotating shaft, the possible consequences should the hazard occur, and how to avoid the hazard.
- **Used on:** Articulating cranes that are powered by a rotating shaft-driven pump
- **Placement:** One sign each side of vehicle on the frame rail, and any other place where rotating shaft hazard is apparent
- **Quantity:** 2 or more

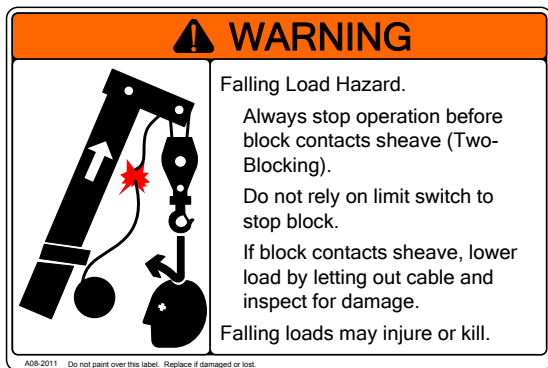

Figure 2.8: Two-Block Warning decal (A08)

- **Function:** To inform the operator of the hazard associated with bringing the sheave(s) into contact with the hook, snatch block, or load; the possible consequences should the hazard occur; and how to avoid the hazard.
- **Used on:** Articulating cranes
- **Placement:** Visible to crane operator
- **Quantity:** 1

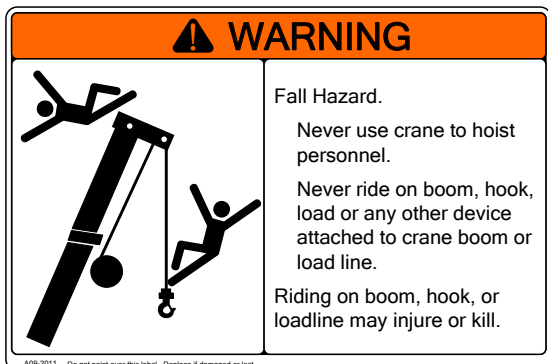

Figure 2.9: Riding on Crane decal (A09)

- **Function:** To inform the operator of the possible consequences of riding on the boom, boom hook, the load, or winch loadline and how to avoid the hazard.
- **Used on:** Articulating cranes
- **Placement:** Visible to crane operator
- **Quantity:** 1



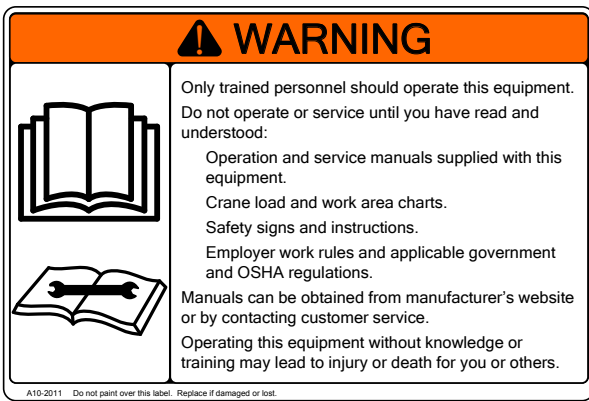

Figure 2.10: Untrained Operators decal (A10)

- **Function:** To inform the operator of the need for proper training, familiarity with safe operating procedures, and the possible consequences of operation without training.
- **Used on:** Articulating cranes
- **Placement:** Visible to crane operator
- **Quantity:** 1

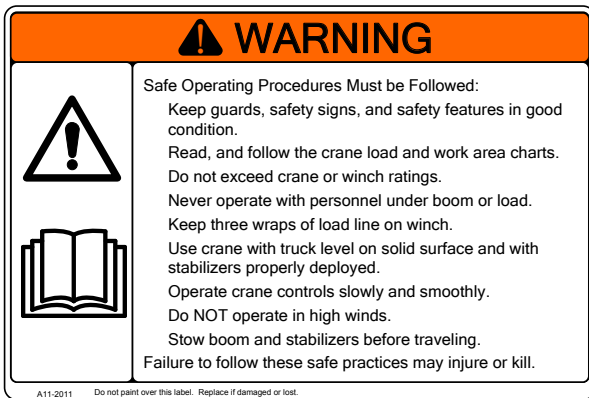

Figure 2.11: Operational Procedures decal (A11)

- **Function:** To inform the operator of safe operating procedures for the crane and the possible consequences of operation without taking those precautions.
- **Used on:** Articulating cranes
- **Placement:** Visible to crane operator
- **Quantity:** 1

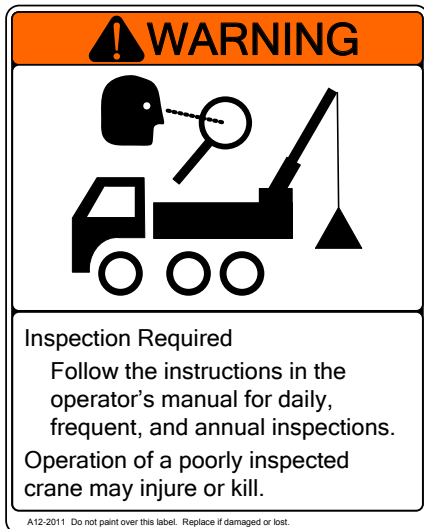

Figure 2.12: Inspection decal (A12)

- **Function:** To inform the operator of the hazard associated with operation of poorly inspected crane, the possible consequences should the hazard occur, and how to avoid the hazard.
- **Used on:** Articulating cranes
- **Placement:** Visible to crane operator
- **Quantity:** 1



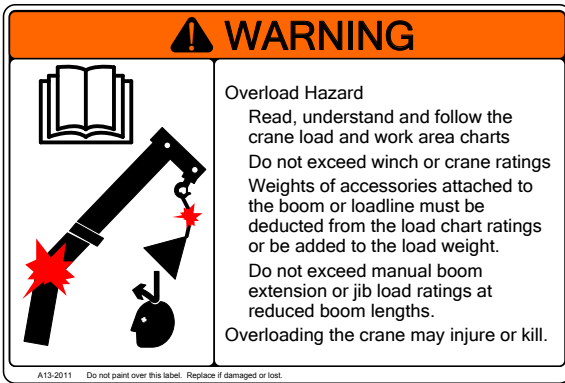

Figure 2.13: Crane Load decal (Label A13)

- **Function:** To inform the operator of precautions necessary to prevent overloading the crane and the possible consequences of not taking those precautions.
- **Used on:** Articulating cranes
- **Placement:** Visible to crane operator
- **Quantity:** 1



Figure 2.14: Boom Extension decal (A14)

- **Function:** To inform the operator of precautions necessary in the safe deployment of manually operated extension booms and the possible consequences of not taking those precautions.
- **Used on:** Articulating cranes
- **Placement:** Visible to crane operator
- **Quantity:** 1

This page intentionally left blank



## CHAPTER 3: Control Systems

This chapter presents the criteria, rules, and standards for the inspection and safe use of the articulating crane control systems. This includes the manual control station, remote control station, and top seat control station.

### 3.1 General precautions

Operator's station controls must be labeled with their designated functions and directions, as recommended by the manufacturer.







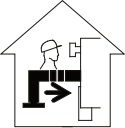
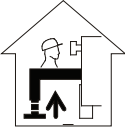

 Stabilizer beam	 Stabilizer cylinder
 Slewing	 Inner boom
 Outer boom	 Extension boom
 Fly jib main boom	 Fly jib extension
 Rotator	 Grab
 Hoist line winch	

Figure 3.1: Typical operator's station control function labels

Check for the following:

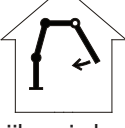
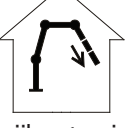
- Control function labels must be legible.
- Ensure that controls return freely to their neutral position before engaging power source.
- Ensure that overload protection (OLP) systems have not been compromised.
- Remote control unit carrying aids (belt or neck strap) should be used when supplied.
- The equipment must have a horn that is either built into the equipment or is on the equipment and immediately available to the operator. If a built-in horn is not working properly, it must be tagged-out or removed. If a removable horn is not working properly, it must be removed (OSHA 1926.1415).

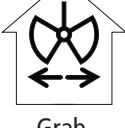
### 3.2 Manual control station

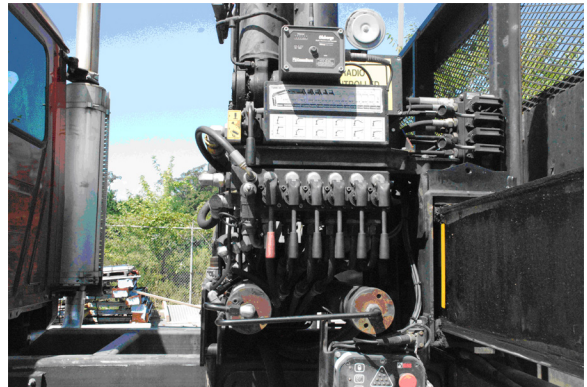

Figure 3.2: Manual control station

Check for the following:

- The manual control station should be located where it can be operated from the ground, from an elevated stand-up platform, or the top-mounted seat.
- Flooring of elevated stand-up platforms must be made of slip-resistant material.
- Elevated stand-up platforms must have designated handholds to access and egress the platform. Do not use controls or hoses as handholds.
- Use three-point contact (both feet and one hand, or both hands and one foot) for access and egress of elevated platforms (Figure 3.3).

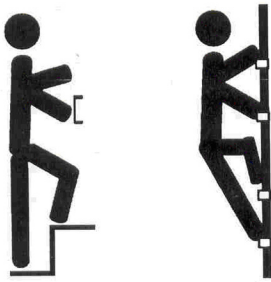
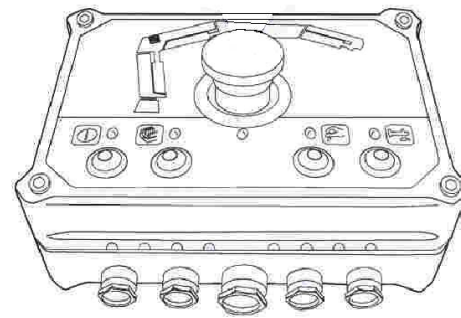

Figure 3.3: Use three-point contact (both feet and one hand, or one foot and both hands) when climbing to and from control station



Figures 3.5a and 3.5b: Radio remote control

### 3.3 Cable and radio remote controls

Check for the following:

- Ensure the cable on a cable remote does not become entangled or a tripping hazard.
- To prevent damage to the remote control, only put it down in a safe, dry location.
- To prevent unauthorized operation, switch the remote OFF and remove the key when not in use.
- If any of the controls are not working properly, do not use the remote; use manual controls instead.
- Use extreme caution while walking with an active remote.
- Ensure your path is clear of any slipping or tripping hazards before walking.
- Never walk backwards when using a remote control.



Figure 3.4: Cable remote control

### 3.4 Top seat control station



Figures 3.5a & 3.5b: Top Seat Control Station

- Operator must maintain three points of contact with the crane when accessing and exiting the control station (Figures 3.5a and 3.5b).
- Use caution when entering and exiting the control station to avoid unintentional movement of controls.
- Only one person may occupy the operator's station area (except during training).



## CHAPTER 4: Ancillary Attachments



Figure 4.1: Typical articulating crane attachments

This chapter presents some of the various attachments that can be used with an articulating crane. As depicted in Figure 4.1, these attachments include (from left to right):

- Brush grapple
- Stone grapple
- Brick grab
- Clam bucket
- Log grapple
- Barrier clamp

### 4.1 General precautions

- Use only lifting attachments (basket, grapple, forks, auger, etc.) that are approved by the crane manufacturer.
- When connecting and disconnecting the hydraulic connections (often called *quick disconnections* or *QDs*) to the accessory, always clean the connections and be careful not to pinch your fingers or hands.
- When using add-on (aftermarket) lifting accessories, always follow the instructions supplied by the lifting accessory manufacturer.
- Do not exceed the load rating of the attachment; note that the attachment's load rating may be less than the crane's rating.
- Account for any load handling deductions (e.g., weight of attachments).
- Ensure that the attachment is designed for use on articulating cranes.
- Only use attachments for their designed purpose.
- Refer to the accessory manufacturer's operating instructions for the attachment before using it.

- Before operating equipment, understand the descriptions, operations, and maintenance requirements for the attachments, components, and base machine (crane).
- When using pallet forks, make sure the fork tines are centered under the load to balance the load and lift level.
- Do not push down on the lifting attachment with the boom.
- Do not allow lifting attachments to push upward on the boom.
- Never lift personnel with any attachment unless it's a personnel lifting device that is approved by the crane manufacturer and is attached or pinned to the last boom extension. See OSHA 1926.1431 for complete guidance and restrictions on hoisting personnel.

This page intentionally left blank



## CHAPTER 5: Articulating Boom Loader and Fork Assembly

This chapter presents the criteria, rules, and standards for the inspection and safe use of the articulating boom loader hydraulic fork assembly.

### 5.1 General precautions

- Use the right attachment for materials to be lifted.
- The plastic supports on the back of the fork must closely fit the load to prevent shifting and damage to the load.
- The load shall rest on the load handling forks evenly and be engaged in a manner that places the load center of gravity directly on or between the forks.
- The swivel fork must always be able to float freely and never allow the fork or load to rest against the crane boom (Figure 5.1).

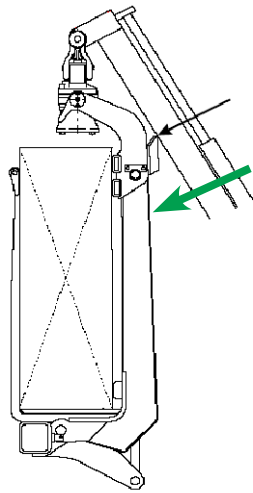

Figure 5.1: Fork or load should never rest against crane boom (as shown by arrow)

### 5.2 Safety precautions

The load should not pass over the operator or any other person (Figure 5.2).

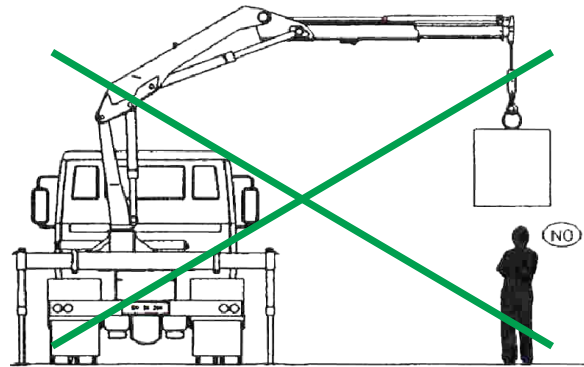

Figure 5.2: Never pass load over operator or any other person

- Test the fork control functions prior to use—improper rotation or accidental opening of fork tines may cause loss of the load.
- To maintain stability, keep the load as close to the ground and as short a radius as practical.
- Do not allow the load or attachments to swing or contact any part of the crane.
- During transport, the fork assembly must be stowed and secured on the vehicle in such a manner that it cannot swing out.
- Overloading the fork assembly could cause the fork assembly to open uncontrollably.
- Starting and stopping, rotating the crane and fork assembly, and opening and closing of the forks shall be done under controlled speed to prevent loss of control or load.
- Use the proper fork assembly to match the application to provide proper load support.
- When handling drywall, close the fork as soon as the load clears the truck bed or ground surface.
- The transport of persons is prohibited using a fork assembly attachment under any conditions—***no riders on forks or load!***
- When practical, the load should be clamped between the tines and backrest of the fork assembly.

- Adjust the width of the fork tines as necessary to safely lift different-sized loads.
- The tine locking devices shall be in the locked position for all lifts to prevent load shift or load loss.

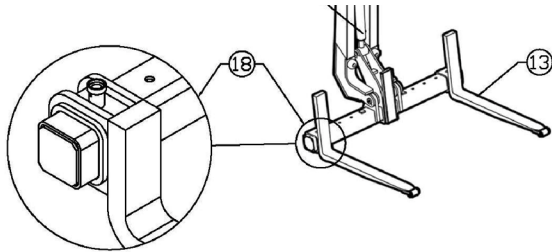

Figure 5.3: Always lock fork tines to prevent load shift

- The fork assembly should not be moved manually to engage the load.
- The operator shall always present the load in a manner that ensures a safe unloading environment.





## CHAPTER 6: Load Charts

This chapter presents various types of load charts and direction on how to read and interpret chart information to verify the load does not exceed the crane's rated capacity.

### 6.1 General precautions

- Load charts must be posted on the crane so that they are visible when the operator is at the control station.
- If a crane is equipped with a remote control, the load charts must be at a level visible to the operator from the ground.
- Load charts must be maintained so they remain legible; never operate a crane without a legible load chart.
- Crane operators must know how to read and understand the crane's load chart(s) and shall not exceed the capacity ratings.

### 6.2 Types of load charts

Articulating cranes typically come with one of two types of load charts. The first—and simplest—is a one-dimensional load chart; the second, less-common variety is a two-dimensional load chart. Samples of each are presented in the following sections.

The details and presentation of the load charts from different crane manufacturers vary, but the concepts apply similarly across all brands.

#### 6.2.1 One-dimensional load charts

One-dimensional load charts show the crane in a horizontal position with various lifting capacities at their associated radii (Figure 6.1).

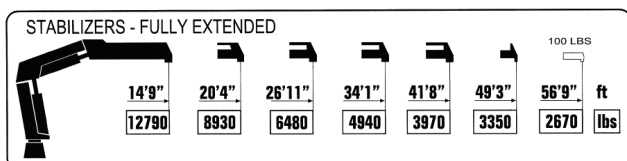

Figure 6.1: Sample one-dimensional load chart

#### 6.2.2 Two-dimensional load charts

Two-dimensional load charts show both the vertical and the horizontal ranges of a boom's lifting capabilities. This type of chart gives the operator a reference as to the crane's capabilities when the crane's hook point moves in the vertical direction as well as horizontally.

As shown in Figure 6.2, two-dimensional load charts specify the boom-lifting capacity for each two-dimensional range on the chart.

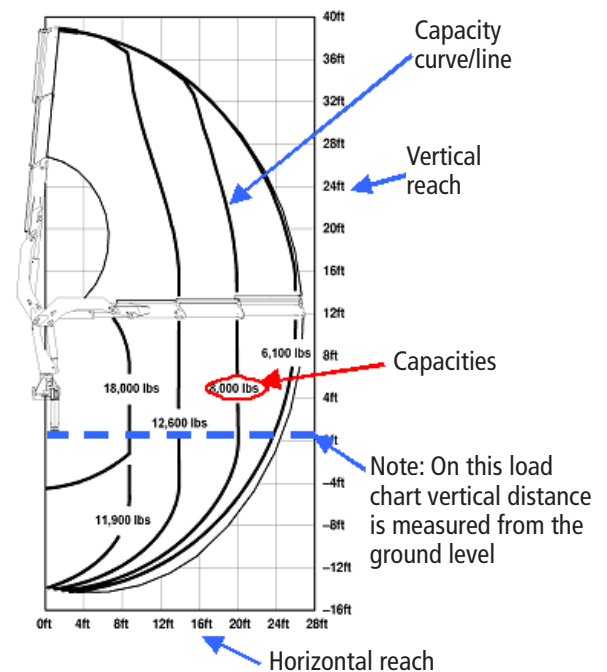

Figure 6.2: Sample two-dimensional load chart

- The crane capacity is shown in two dimensions, horizontal (measured from crane centerline of rotation) and vertical (measured from crane mounting surface or from ground level).
- Capacity lines or curves show what loads can be lifted by the crane at different horizontal and vertical reaches. The load shown on the curve can be lifted anywhere on the curve or anywhere closer to the crane. As with one-dimensional charts, capacities must never be interpolated.

### 6.3 Reading load charts

- Load rating charts are specific to every make and model of crane. Some cranes are equipped with multiple load charts for various operating conditions. ***If your chart does not match the specific crane you are using (and/or the current conditions), notify your supervisor immediately and DO NOT USE THE CRANE.***
- On some load charts, the angle of the inner boom is also stated to indicate what position the boom must be at for the capacities to be valid.
- Interpolation is a technique of estimating what the crane's gross capacity is between two stated values on the load chart. ***Never interpolate when reading and interpreting load charts; always use the next lower capacity.***

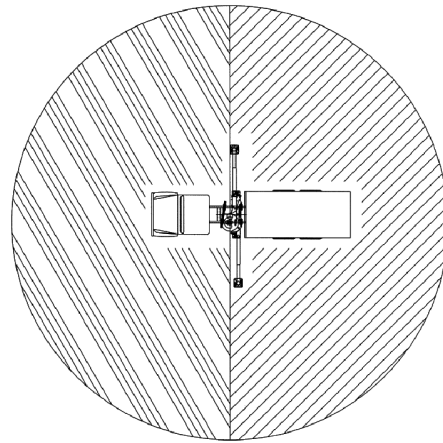
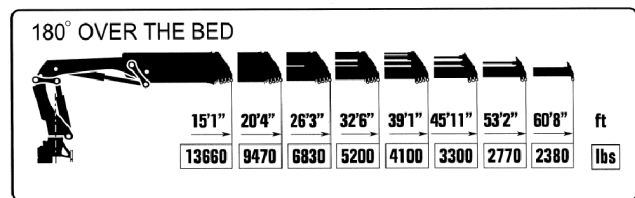

Figure 6.4: 180° over the bed vs. 180° over the front work areas

### 6.4 Charts reflecting stabilizer deployment

- Charts may reflect “Stabilizers Fully Extended” (best position for maximum stability and rating) or “Stabilizers Mid Span” (position reflects reduced stability and reduced ratings).
- Rated capacities indicate the radius and rated lifting capacity for the crane in the position shown.



Figures 6.5a & 6.5b: Sample work area load charts; top chart for lifting over the truck bed; bottom chart for lifting over the truck front

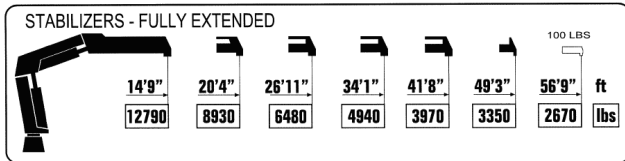

Figures 6.3a & 6.3b: Sample Load charts for stabilizers fully extended (top) vs. mid-span (bottom)

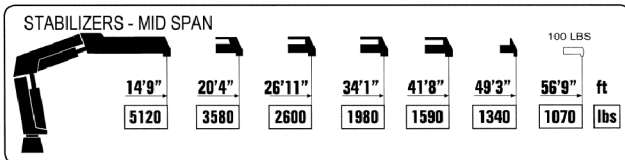
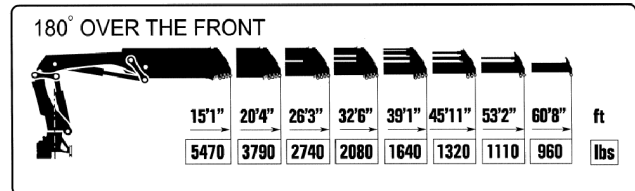

### 6.5 Work area charts (lifting quadrants)

- Rating charts may also identify work areas or lifting quadrants for rated capacities. Articulating boom cranes may use a back 180° (over the rear), a front 180° (over the cab), and/or a 360° chart (Figure 6.4).

### 6.6 Charts reflecting manual boom extensions

- Articulating cranes may be equipped with manual boom extensions that are optional and/or removable. When using manual boom extension(s), do not exceed the rating of the manual extension(s), regardless of the working radius or amount of boom extension (same rating for all radii).
- When the crane is equipped with manual boom extension(s) that are not being used, deduct the weight of the extension(s) from the crane's gross capacity to calculate net capacity. Do not deduct this weight when using the manual extension(s).

## **6.7 Capacity of rigging and attachments**

- The capacity or rating of the rigging or attachment being used may be a limiting factor for the lift.
- Never exceed the rated capacity of the rigging or attachment being used, regardless of what the crane capacity rating shows.

## **6.8 Gross capacity vs. net capacity**

- Capacities shown on load charts are gross capacities. Net capacity is the gross capacity minus the weight of any attachments or other lifting deductions.
- When determining what the crane can actually lift, deduct the weight of all devices below the boom tip; these lifting deductions can include attachments such as pallet forks, hydraulic clamps, rotators, drywall forks, and clam buckets.
- Also deduct from the gross capacity the weight of rigging materials such as lifting slings, shackles, and spreader bars.
- The gross capacity minus the lifting deductions equals the net capacity or what the crane can actually lift (load weight).
- Alternatively, determine the gross load by adding the weight of the rigging and/or attachments to the weight of the actual load, then compare this gross load to the crane rating chart to determine the maximum lifting radius without overloading the crane.

This page intentionally left blank



## CHAPTER 7: Preparation for Crane Setup

This chapter presents criteria, rules, and standards for preparing the crane for setup at a job site, including how to account for various site-specific external hazards that may be encountered.

### 7.1 General precautions

- Do not use equipment for purposes other than what it was designed for.
- Carefully plan each lift before hoisting the load. Lift planning must be done prior to each lift.
- Determine load weight and verify that it does not overload the crane.
- When operating in extreme temperatures, always consult the manufacturer's operator's manual for applicable recommendations.

### 7.2 Lift planning

- Visually inspect the work site.
- Identify any above- and/or below-ground hazards; walk the planned lift route prior to traveling it to check for proximity and voltage of any overhead power lines.
- Determine the radius requirements of the lift.
- Determine the gross and/or net weight of the load.
- Calculate the lifting solution (Section 7.11).

### 7.3 Electrical hazards

- Under OSHA 1926.1407–1409, during assembly/disassembly and operations, the employer must determine whether the crane's movements could take it closer than 20 feet to energized power lines. If so, the employer must take steps to prevent contact. These include de-energizing and grounding the lines, maintaining at least a 20 ft. clearance between any part of the crane and the lines, or maintaining a minimum distance as specified by Table A.
- Tables A and T may only be utilized when the exact voltages of the lines are known. Please consult OSHA 1926 Subpart CC sections 1926.1407–1411 for full details on power line safety requirements.

**Table A—Minimum Clearance Distances**

Voltage (nominal, kV, alternating current)	Minimum clearance distance (feet)
up to 50 .....	10
over 50 to 200 .....	15
over 200 to 350 .....	20
over 350 to 500 .....	25
over 500 to 750 .....	35
over 750 to 1,000 .....	45
over 1,000.....	(as established by the utility owner/operator or registered professional engineer who is a qualified person with respect to electrical power and distribution.)

**Note:** The value that follows "to" is up to and includes that value. For example, over 50 to 200 means up to and including 200kV.

**Table T—Minimum Clearance Distances While Traveling With No Load**

Voltage (nominal, kV, alternating current)	Minimum clearance distance (feet)
up to 0.75 .....	4
over 0.75 to 50 .....	6
over 50 to 345 .....	10
over 345 to 750 .....	16
over 750 to 1,000 .....	20
over 1,000.....	(as established by the utility owner/operator or registered professional engineer who is a qualified person with respect to electrical power and distribution.)

**Note:** Table T is used in conjunction with the travel requirements in 1926.1411.

- When entering the job site, be sure to maintain minimum transport clearance away from electrical power lines as specified in Table T.
- Select a work zone so proper minimum clearances can be maintained while operating the crane.
- Minimum clearance warning signs for electrical hazards during both operation and transport shall be posted on the crane.
- Be sure to take into consideration any potential sway or whipping of energized electrical lines caused by wind when determining the safe working proximity to those lines.

- Do not rely on electrical wire coverings for protection from energized lines; step potential and touch potential may still exist (Figure 7.1). The greatest danger is faced by a person who simultaneously touches both the crane and the ground, but a person who is near, but not touching, the crane can also suffer electric shock.

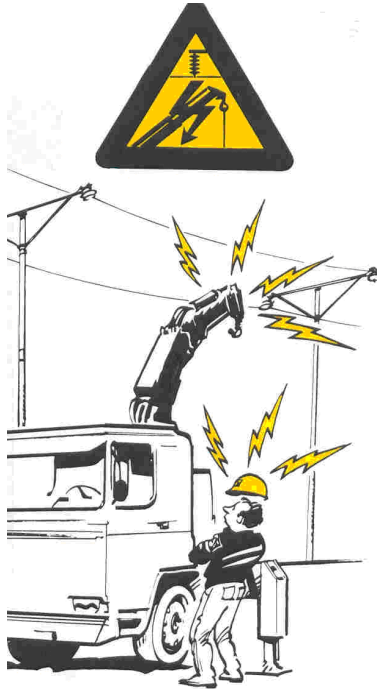

Figure 7.1: Be aware of all potential electrical hazards

- Electrical hazard warning signs should be posted on all four sides of the vehicle (Figure 7.2).

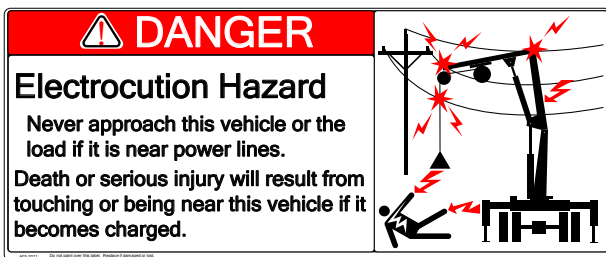

Figure 7.2: Electrocution Hazard decal

- A spotter is required to help maintain the required clearances whenever the boom's length (in the crane work zone) can reach the prohibited or danger zone with the electrical lines energized.
- Cranes in transit and in their stowed position shall maintain the required clearances, as specified in Table T (above); see OSHA 1926.1411 for full explanation.

## 7.4 Work site inspection

- Check access and egress to work zone to ensure the crane can safely enter and exit.

- Check for overhead clearances and obstacles.
- When setting up, take into consideration wind, weather, proximity to electrically charged lines, underground hazards, and other safety factors.
- Prior to set-up, carefully examine ground conditions to verify the ground's ability to support the weight of the forces being applied to it.
- Per OSHA Trenching and Excavation guidelines, stabilizers or tires should not be set up closer than 1.5 times the depth of an excavation in sandy or gravel soil; 1.0 times the depth in solid or compacted soils or next to cellar or basement walls (Figures 7.3a & 7.3b).

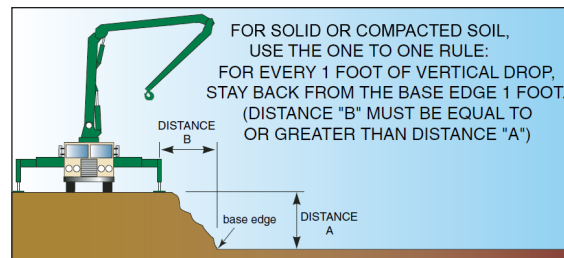

Figures 7.3a & 7.3b: Guidelines for setting up stabilizers near a vertical drop

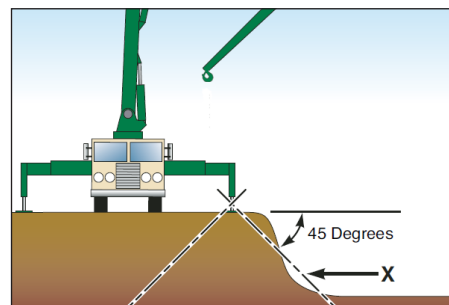

- Position and orient the crane truck to lift over the proper lifting quadrants.
- Set up truck level, within allowable range specified by manufacturer (Figure 7.4).

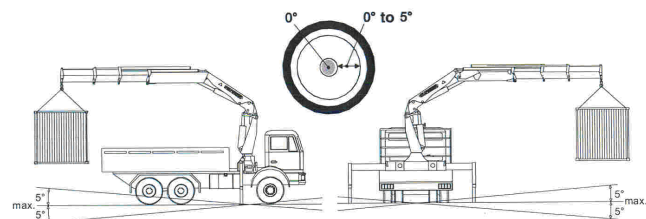

Figure 7.4: Level truck within manufacturer's specifications

- Determine maximum height and radius within the work zone for where the load is to be placed.

- Establish and clearly mark the work zone to prevent unauthorized entry (Figure 7.5).

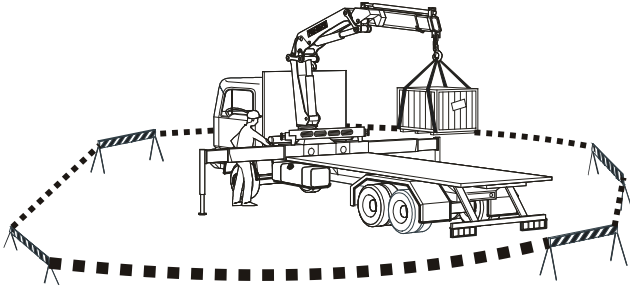

Figure 7.5: Establishing and marking work zone

- Set the parking brake and place wheel chocks (Figure 7.6).



Figure 7.6: Setting wheel chocks

## 7.5 Operator's control area(s)

- Keep the controls clean and free of oil, mud, ice, and snow.
- Make sure the steps and handrails are clean and not slippery.
- Use three-point contact at all times when entering or exiting (Figure 7.7).

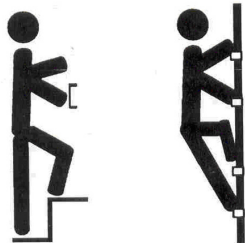

Figure 7.7: Use three-point contact (both feet and one hand, or one foot and both hands) when climbing to and from control station

- Do not use the controls or hoses as a handhold.
- Do not jump into or out of the machine.

## 7.6 Stabilizers

- Stabilizers shall be locked in the retracted position during transit.
- Prior to taking the boom out of the cradle stowed position, stabilizers shall be properly deployed and locked, if so equipped by the manufacturer (Figure 7.8).

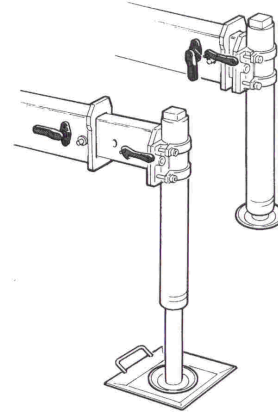

Figure 7.8: Deploying and locking stabilizers.

- Stabilizers shall be fully deployed per the manufacturer's load chart specification; *there may be multiple load charts based on different stabilizer spans.*

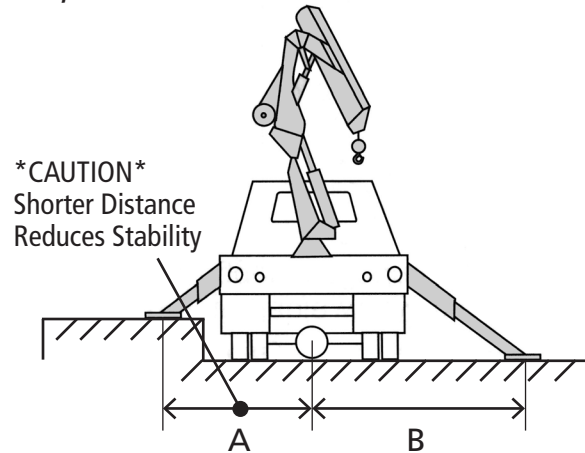

Figure 7.9: Setting up stabilizers on uneven ground.

- Stabilizers shall be visible to the operator when extending and setting unless assisted by another person.
- Ensure all limbs are kept well away from the danger areas to prevent crushing or pinching when deploying or retracting stabilizers (Figure 7.9).



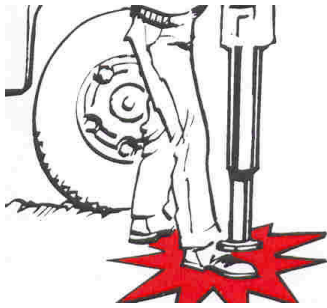

Figure 7.10: Keep limbs away when deploying or retracting stabilizers

- Stabilizers are not to be used for purposes other than stabilizing the crane (e.g., do not use stabilizers as a parking brake).
- Do not operate the stabilizer beam controls while the stabilizer legs are contacting the ground.
- Do not stand in the path of the stabilizer beams when deploying them (Figure 7.11).



Figure 7.11: Stay away from stabilizer beams when they are moving

- To avoid instability, all steering and drive tires must remain firmly on the ground when setting up stabilizers (Figure 7.12).



Figure 7.12: Keep all steering and drive tires on ground when setting up stabilizers

- Do not set stabilizers over underground hazards, cavities, or drain covers (Figure 7.13)

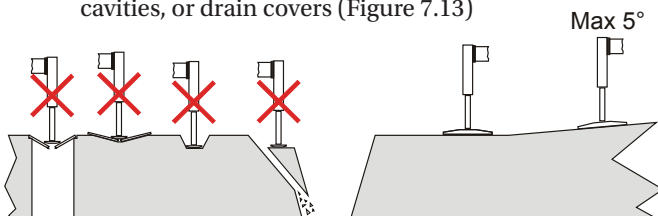

Figure 7.13: Avoid underground hazards when setting up stabilizers

- Do not operate stabilizer controls while the boom is elevated.
- Articulating cranes shall be leveled to the manufacturer's specifications prior to unstowing the boom.
- Stabilizer legs should not be set on uneven or slippery surfaces (Figure 7.14, A & B).

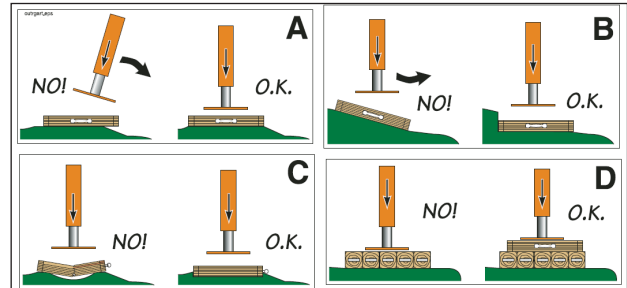

Figure 7.14: Incorrect and correct use of stabilizer support pads/plates

- Most stabilizers require additional support pads and/or plates; refer to the manufacturer's operator's manual (Figure 7.14, C & D).

## 7.7 Leveling

- Means must be provided to determine levelness, such as a spirit level or bull's eye level (Figure 7.15).



Figure 7.15: Sample bull's eye level

- Cranes and boom trucks must be level to within the manufacturer's specifications prior to deploying the boom.
- If a built-in crane level indicator is not working properly, it must be tagged-out or removed. If a removable crane level indicator is not working properly, it must be removed.



## 7.8 Cribbing

- Cribbing is solid material placed under the stabilizer pads to disperse the downward pressure over a larger area of the ground and eliminating sinking (Figure 7.16).



Figure 7.16: Sample cribbing

- Cribbing shall be of sufficient size and strength to prevent crushing, bending, or shear failure.
- Use appropriate cribbing to protect the surface of concrete or asphalt against imprinting or damage caused by the stabilizer pad.

## 7.9 Wind and weather

- Operators should have a means of determining the speed of the wind, such as a handheld anemometer or Beaufort wind scale chart (Figures 7.17, right, and 7.18, next page).

Figure 7.17: Handheld anemometer



- Winds can affect the load of all articulating cranes, regardless of the crane's capacity.
- Do not operate the crane in wind speeds exceeding limits established by the manufacturer.
- Wind can cause side loading of a boom, so take appropriate precautions in windy conditions—use a tag line, and shrink wrap or belly lash the load to make sure part of it can't break off.
- Potential wind effects should be considered during lift planning as well as during operation, particularly if conditions change. The effect of the wind can differ greatly based upon factors such as how high the load is, the length at which the boom is extended, the weight of the load, and/or the shape of the load.
- If lightning is present, stow the boom immediately.

## 7.10 Lifting solution

- Calculate and determine a lifting solution prior to every pick, no matter how simple; in some cases this can be done in your head.
- Account for all load handling deductions, including weight of forks, rotators, hook(s), and rigging.
- Be aware that any of the following items can create a limiting factor beyond the crane's calculated net capacity:
  - Wire rope limit
  - Hoisting hook
  - Lifting attachments
  - Rigging
  - Winch capacity

## BEAUFORT WIND SCALE

Force	Wind (Knots)	WMO Classification	Appearance of Wind Effects	
			On the Water	On Land
<b>0</b>	<1	Calm	Sea surface smooth & mirror-like	Calm, smoke rises vertically
<b>1</b>	1–3	Light Air	Scaly ripples; no foam crests	Smoke drift indicates wind direction; still wind vanes
<b>2</b>	4–6	Light Breeze	Small wavelets; crests glassy, not breaking	Wind felt on face; leaves rustle; vanes begin to move
<b>3</b>	7–10	Gentle Breeze	Large wavelets; crests begin to break; scattered whitecaps	Leaves and small twigs constantly moving; light flags extended
<b>4</b>	11–16	Moderate Breeze	Small waves 1–4 ft. becoming longer; numerous whitecaps	Dust, leaves, and loose paper lifted; small tree branches move
<b>5</b>	17–21	Fresh Breeze	Moderate waves 4–8 ft. taking longer form; many whitecaps; some spray	Small trees in leaf begin to sway
<b>6</b>	22–27	Strong Breeze	Larger waves 8–13 ft.; whitecaps common; more spray	Larger tree branches moving; whistling in wires
<b>7</b>	28–33	Near Gale	Sea heaps up, waves 13–20 ft; white foam streaks off breakers	Whole trees moving; resistance felt walking against wind
<b>8</b>	34–40	Gale	Moderately high (13–20 ft) waves of greater length; edges of crests begin to break into spindrift; foam blown in streaks	Whole trees in motion; resistance felt walking against wind
<b>9</b>	41–47	Strong Gale	High waves (20 ft.); sea begins to roll; dense streaks of foam; spray may reduce visibility	Slight structural damage occurs; slate blows off roofs
<b>10</b>	48–55	Storm	Very high waves (20–30 ft.) with overhanging crests; sea white with densely blown foam; heavy rolling; lowered visibility	Seldom experienced on land; trees broken or uprooted; considerable structural damage
<b>11</b>	55–63	Violent Storm	Exceptionally high 30–45 ft.; foam patches cover sea; visibility more reduced	
<b>12</b>	64+	Hurricane	Air filled with foams; waves over 45 ft.; sea completely white with driving spray; visibility greatly reduced	

Figure 7.18: Beaufort Wind Scale



## CHAPTER 8: Crane Operation

This chapter presents criteria, rules, and standards for safe crane operation.

### 8.1 General precautions

- The operator's manual shall be with the crane at all times.
- Read the operator's manual prior to operating the crane.
- Operation of cranes varies by make, model, and manufacturer. Become familiar with the crane, controls, and load charts before attempting to operate it. Pay particular attention to the folding and unfolding process, as severe damage or injury can occur with the wrong movement or sequence.
- Do not operate the crane unless there is sufficient light to see the boom tip and your load in all configurations. Lighting can be either natural or supplied.
- Before engaging the power take-off (PTO), ensure that all controls are in the off or neutral position and that all personnel are in the clear.
- Engage the PTO and set the truck RPM per the manufacturer's recommendations.
- Establish a minimum 10 ft. safe distance around the work zone (Figure 8.1). The work zone should be an area designated by means of recognized safety identifiers (such as cones, tape, or barriers) for the purpose of preventing non-authorized persons from entering (Figure 8.2).

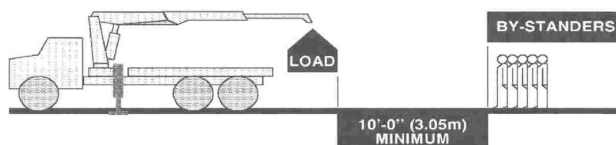

Figure 8.1: Establish a work zone with at least a 10 ft. safety perimeter

- Ensure there are no unauthorized persons inside the work zone before you begin working.

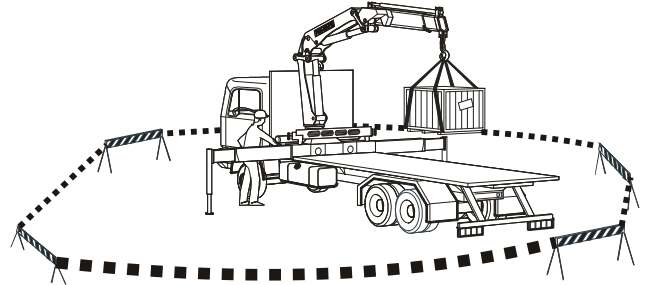

Figure 8.2: Establish a well-marked work zone and ensure no unauthorized persons are inside the designated area before operating crane.

- If load or placement area is not visible from operator's position, establish proper crane communication with a qualified signalperson.
- Always ensure the person giving signals is a safe distance from the load.
- Never perform a maneuver that causes the load to pass over the operator's position or another person (Figure 8.3).

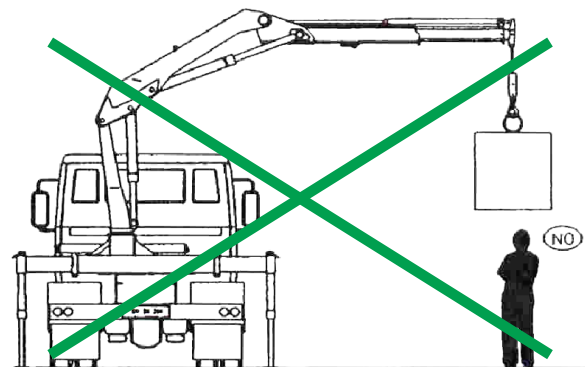

Figure 8.3: Never pass load over operator or any other person

- When the crane has multiple operator's positions, use the operator's position that ensures maximum visibility.
- Do not move the vehicle with the boom unstowed (Figure 8.4).

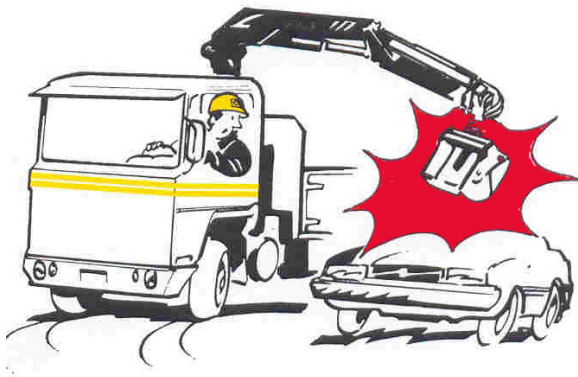

Figure 8.4: Do not travel with boom unstowed

- Do not push or drag loads from the side.
- Always lift the load clear of the ground (resting surface) with boom lift or hoist before rotating the boom, extending or retracting the boom, or moving the load in any manner (Figure 8.5).

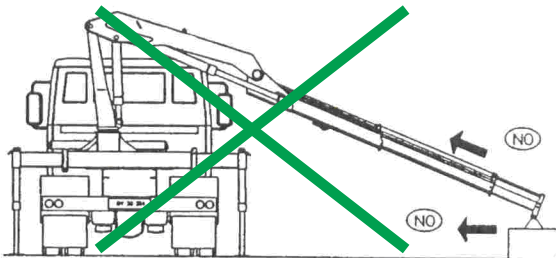

Figure 8.5: Lift the load clear of the ground before other movement.

- When working with elevated loads, always ensure there is adequate clearance above and below the load.
- Removing part of the load may affect boom deflection, so adjustments may be required.
- When operating at high boom angles, do not lower the extended boom because this can cause an overload situation; instead, retract the boom extensions first.
- Always operate the crane with smooth and gentle lever movements. Do not jerk the controls to full speed or from one direction to the other; doing so is a major cause of shock loading (Figure 8.6).



Figure 8.6: Use gentle lever movements to avoid shock loading.

- When the cylinder is approaching the end of its stroke, slowly move the lever to its neutral position gradually; sudden movements can cause damage to the crane.
- Avoid quick or jerky movements at full extension as they can cause undue stress and wear to the crane (Figure 8.7).

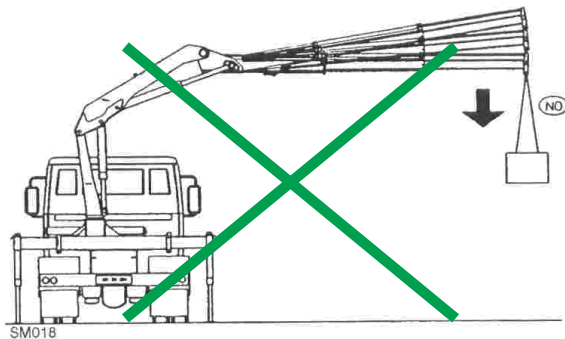

Figure 8.7: Avoid quick or jerky movements at full extension.

- Remove or secure all attachments (extensions, grapple, forks, etc.) when they are not being used.
- Always adhere to the load chart(s); failure to do so can cause damage or injury.
- Never disconnect or tamper with the safety systems.
- To minimize load swing, position the boom tip directly over the load's center of gravity prior to lifting.
- When releasing manual extension boom (pins), position the boom as flat as possible. To avoid injury, do not stand directly in line with the extension travel path.
- Do not use any of the crane's booms to push downward onto anything.
- Do not operate the crane when there are any loose objects on the load or boom.

- Do not allow personnel to ride the hook, boom, or load (Figure 8.8).

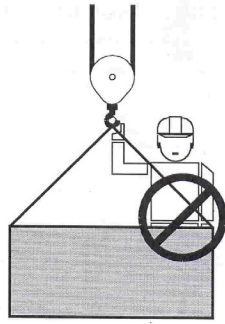

Figure 8.8: Do not allow anyone to ride on hook, boom, or load.

- Use only appropriate personnel baskets, as directed by the crane manufacturer.
- Ensure no part of the boom, ancillary equipment (attachment), or load can come in contact with any obstructions.
- Do not permit ancillary equipment to push upward on the boom. Closing open clam buckets or grapples can do damage this way, particularly if they are placed open on a very hard material.
- Use tag lines where required or necessary (see section 8.13).
- *If the overload protection (OLP) safety system activates, operate any function that reduces the boom radius to continue.*

## 8.2 Operator responsibilities

- Only one operator shall operate the crane at a time.
- Only one person is allowed on a top seat control station or catwalk at a time (except during training).
- Do not use the top seat control station or catwalk as an access to the roof or other elevated areas.
- Do not engage in any distracting activities while operating the crane (Figure 8.10).
- Do not operate the crane when physically or mentally unfit or under the influence of alcohol or controlled substances.
- Operators are responsible for all operations under their direct control, including setting up the crane, knowing the accurate weight of the load, and determining the lifting solution.
- *If any doubt exists about the safety of a lift, consult with your supervisor before handling the load.*
- After receiving a local weather storm warning, secure the crane according to the manufacturer's recommendations.

## 8.3 Controlling load swing

- Start the boom rotation very slowly; keep the boom tip above the load; accelerate slowly.
- To stop the load movement, begin slowing well in advance of target area; always keep the boom tip above the load.

## 8.4 Attaching or engaging the load

- Only qualified persons (e.g., crane operators, certified riggers) shall attach rigging to a crane's hook.
- The load shall be attached to the hook by means of slings or other devices of sufficient capacity.
- The hook shall be brought into place so as to minimize swinging.

## 8.5 Handling the load

- Take care to avoid lowering the boom and increasing the working radius in such a manner that the boom and/or stability become overloaded and unsafe.
- Do not handle loads with the outer boom or fly jib in a negative position (Figure 8.9).

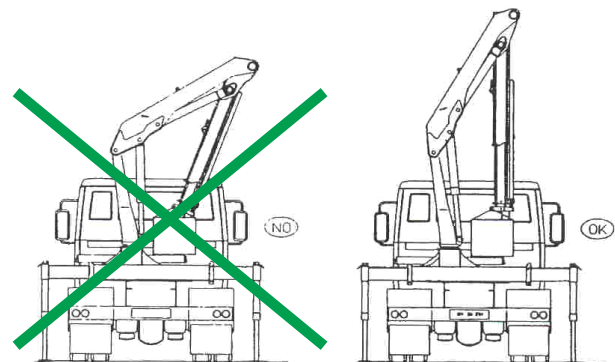

Figure 8.9: Never handle loads with the outer boom or fly jib in a negative position

- Never load the crane beyond the specifications of the load chart.
- Prior to the lift, calculate the load weight and range capacity, accounting for the full range of potential configurations during the entire lift.
- Ensure that all lifting devices below the hook (rigging) are of appropriate lifting capacity to handle the load being lifted.
- Only lift freely suspended loads.
- Booms shall not be side loaded because doing so can cause boom damage, collapse, or failure; side loading can be caused by lifting out of level, dragging the load, or operating in strong or gusty winds.



## 8.6 Safety and performance systems

### 8.6.1 General precautions

- Never disconnect or tamper with the safety systems.
- The simplest boom system is a standard folding articulating crane with no performance-enhancing features.
- Some cranes are designed with a mechanical leverage linkage device (link) attached to the column and inner boom; this device improves the crane's ability to lift tall loads near a crane's base and at high boom angles (Figure 8.10).

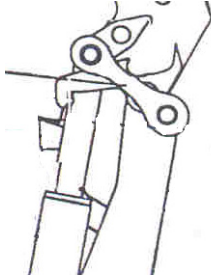

Figure 8.10: Mechanical leverage linking device ("link")

- Some cranes have links only between the inner and outer booms; these links provide a straight-line lifting curve at longer reaches.
- Some cranes have both inner and outer link systems and provide the benefits of both.

### 8.6.2 Overload protection (OLP) systems

- Many articulating cranes come equipped with rated-capacity limiting devices (overload protection systems) that prevent the crane from exceeding its gross capacity.
- Not all cranes are equipped with OLP systems, but all cranes manufactured after November 8, 2011, must have an OLP system (OSHA 1926.1416).
- Articulating crane operators must know how to read and understand the crane's load chart(s) and shall not exceed the crane manufacturer's lifting capacity ratings.

## 8.7 Load movement

- Do not lift in any quadrant unless rated by manufacturer.
- All loads shall be well secured and balanced before they are lifted more than a few inches.
- Be sure the lift and swing path are clear of obstructions.
- Be sure that all persons are clear of the swing radius of the load.
- Lift and move the load smoothly, always keeping the load as close to the ground as practical.

- Do not drag loads sideways or from the front (Figure 8.11).



Figure 8.11: Never drag a load sideways

- Check the hydraulics each time a maximum-rated load is handled by raising it a few inches and checking for boom drift (unintended slow lowering).
- Do not move the load or attachments in such a way that they can make contact with any portion of the crane (Figure 8.12).

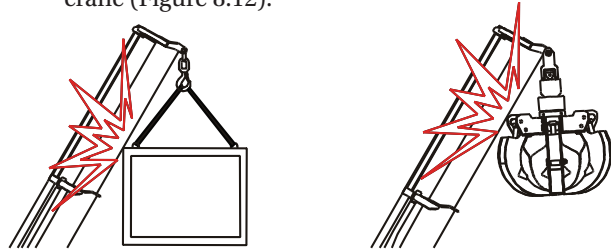

Figure 8.12: Never allow the load or attachments to come in contact with the crane

## 8.8 Load placement

- Do not rest loads on structures of unknown load-bearing capacity.
- No one shall stand or pass under an elevated load.



Figure 8.13: Overhead hazard warning

## 8.9 Leaving the crane unattended (when leaving the work zone)

- Land the load—do not leave suspended.
- Lower the boom.
- Disengage the main power source/power takeoff (PTO) to prevent unauthorized use.
- Stop the engine and secure the key.

## 8.10 Power failure

- In case of power failure, set all brakes and locking devices.
- Move all power controls to the off or neutral position.
- If load can be controlled, land the suspended load.

## 8.11 Ending operations

- Booms requiring a boom support may need to be reset on level ground prior to transport (e.g., ABL booms).
- Secure the boom system and/or attachments sufficiently so as to restrict movement, as recommended by the manufacturer.
- Prior to transit, always fold or stow the crane boom as directed in the operator's manual.
- Raise the stabilizer legs completely prior to retracting the stabilizer beams completely.
- Ensure the stabilizer beam locks are engaged and working properly.
- Disengage PTO, stow chocks, and secure all loads on truck bed for travel.
- Perform final walk-around visual check to ensure the crane is ready for transit.
- Do not use the crane boom for towing.
- Check exit path from job site to ensure there are no obstructions, such as low tree limbs or other overhanging obstacles.

## 8.12 In transit (unloaded or loaded)

- The vehicle driver must know the total height, axle loads, and gross vehicle weight (including crane, ancillary equipment, and load) and proceed accordingly.
- Ensure bridge ratings are sufficient to handle the weight of the truck, crane and load traveling across it.
- Travel only with the boom fully retracted and in a traveling (stowed) position (Figure 8.14).



Figure 8.14: Always travel with the crane properly stowed.

- Never travel with a load suspended from the crane.
- When in transit, maintain proper clearance from electrical power lines (Figure 8.15); *note that when stowed and in transit, the distance to power lines is not the same as when operating the crane (per Figure 7.2).*

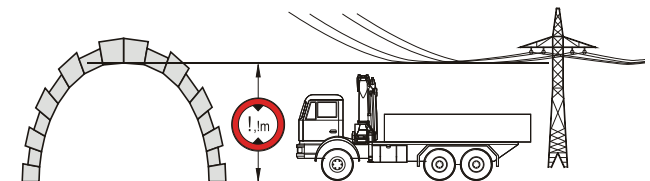

Figure 8.15: Maintain required clearances from tunnels and power lines when in transit.

## 8.13 Tag lines or guide ropes

- Non-conductive tag lines are required when working in the proximity of energized electrical lines.
- Tag lines shall be used on all loads that swing or rotate freely.
- Tag lines shall be held only by experienced persons.
- Never wrap the tag line around yourself, behind yourself, or around your elbow for leverage.
- Avoid carrying or guiding loads over people.

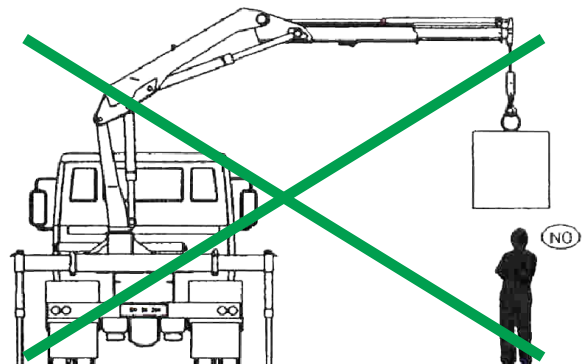

Figure 8.16: Never pass load over operator or any other person

## 8.14 Maintenance and service

- Only authorized personnel shall perform maintenance functions on the crane; then only at the direction of a supervisor.
- Maintenance, inspection and repair personnel are permitted to operate the equipment only where all of the following requirements are met:
  - The operation is limited to those functions necessary to perform maintenance, inspect the equipment, or verify its performance.
  - The personnel either:
    - » Operate the equipment under the direct supervision of an operator who meets the requirements of § 1926.1427 (Operator qualification and certification); or
    - » (ii) Are familiar with the operation, limitations, characteristics, and hazards associated with the type of equipment.
- Maintenance and repair personnel must meet OSHA's definition of a "qualified person" with respect to the equipment and maintenance/repair tasks performed.
- Carry out periodic maintenance according to the crane's maintenance manual.
- Use only original equipment manufacturer (OEM) equipment and parts for repairs.
- Disengage the PTO before any service repairs are performed.
- Do not disconnect any hydraulic hoses or components while there is still pressure in the lines.
- Stand clear of high pressure hydraulic fluid leaks—ingested or injected hydraulic fluid can cause serious illness or even death.
- Keep the crane free of oil and dirt buildup to assist in the visual inspection of the crane.
- Never tamper with hydraulic valve pressure settings.
- Immediately repair or have repaired any components found to be inadequate.
- Welding or drilling of the crane must be carried out by the manufacturer or a manufacturer's representative.
- Before welding anything on the carrier truck, always:
  - Consult manufacturer or representative for authorization
  - Ground the welder as near the welding site as possible
  - Disconnect all connections to the crane's remote control power box
  - Disconnect the truck batteries





## CHAPTER 9: Crane Inspection

This chapter presents both what is recommended and what is required to inspect a crane for service.

### 9.1 General precautions

- Articulating cranes shall be inspected by a competent person at the start of each shift, following the manufacturer's inspection recommendations, ASME B30.22, and/or OSHA 1926.1412.
- The crane and attachments should be observed while in use for signs of defects or operating problems.
- Review operator's manual for additional items to check.
- Never use your hand to check for fluid leaks; use a piece of cardboard.
- If high-pressure fluid comes in contact with your skin, consult a doctor immediately.
- Do not allow unauthorized personnel to approach the hoses or cables while the machine is in use.

### 9.2 Monthly inspections

- Monthly inspections are to be carried out in accordance with the manufacturer's recommendations, ASME B30.22, and/or OSHA 1926.1412.
- Records of monthly inspections are required, and are to be maintained for 90 days.
- Conditions examined during the frequent inspection shall be determined if they are a hazard or not.
- Hazardous deficiencies shall be corrected before the crane use continues.

### 9.3 Annual inspections

- Annual inspections are to be carried out in accordance with the manufacturer's recommendations, ASME B30.22, and/or OSHA 1926.1412.
- Records of annual inspections shall be maintained for 12 months.
- Noted deficiencies shall be repaired and/or defective parts replaced before use continues.

- *A crane that has been idle (not in use) for more than three months shall receive a monthly inspection as designated by the manufacturer or ASME B20.22.*

### 9.4 Cranes not in regular use

- *A crane idle for more than three months shall be given an inspection equal to the monthly inspection requirements indicated in section 9.2 before placing it in service.*
- *Inactive cranes should be started up every 30 days and the hydraulics run through a complete use cycle. This keeps the seals moist and may reduce the possibility of a hydraulic failure once regular use has begun again.*

### 9.5 Articulating crane inspection checklist

An example of an inspection checklist—the Articulating Crane Council of North America (ACCNA) Inspection Checklist—is provided in Appendix A (pages 51–54).

This page intentionally left blank



## CHAPTER 10: **Crane Communication and Signals**

This chapter presents effective crane communication methods and standards for both the operator and the authorized person providing signals. All articulating crane operators must be able to identify the signals, understand their meanings, and be able to apply them in the field.

### **10.1 General requirements**

- Articulating crane operators must know the standard articulating crane hand signals depicted in Appendix B (page 53).
- Hand signal charts must be either posted on the equipment or conspicuously posted in the vicinity of the hoisting operations.
- Operators shall take hand signals from only one person at a time (other than emergency stop or halt signals).
- Emergency stop or halt signals shall be taken from any individual at any time.

- Agree on any special signals in advance.
- Blind load placement requires visual hand signals or an effective coordinated radio system.
- Signals shall be discernible or audible at all times.
- Signal transmission must be through a dedicated channel.

### **10.2 Standard voice signals**

Each voice signal must contain the following three elements, given in the following order:

- Function and direction.
- Distance and/or speed.
- Function stop.





## CHAPTER 11: Load Hooks

### 11.1 General precautions

- Crane hooks are designed and manufactured to lift specific loads. The specified rated load of a hook applies to loads held uniformly in direct tension.
- The rated load applies to new and unused hooks; age, type of service and environmental conditions can alter a hook's ability to handle these loads.
- Hook materials are designed to permanently deform before a failure occurs.
- Load hooks or hook block assemblies shall be labeled with rated capacity and weight.
- Load hooks shall be included in the daily/shift inspection.
- Don't use a hook if it meets rejection criteria.
- Hooks shall be equipped with functioning hook latches (Figure 11.1).

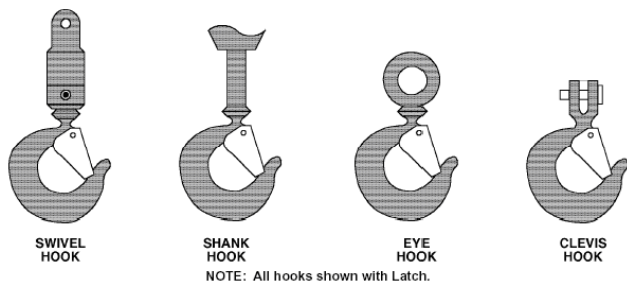

Figure 11.1: Types of load hooks

- Latches shall close the entire throat opening.
- If in doubt about a hook's serviceability, contact the hook manufacturer.
- Never weld attachments to a finished hook; the heat from the welding process will alter and destroy the design properties of the hook material.
- Center the load in the base (bowl-saddle) of the hook to prevent applying load to the hook point.
- Avoid shock loading.
- Do not apply loads of any nature on a latch device.
- Do not place hands, fingers, or body between a hook and the load.
- Do not apply side loads, back loads, or tip loads on a hook (Figure 11.2).

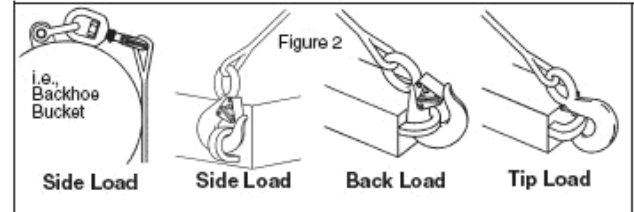

Figure 11.2: Improper hook loading

### 11.2 Hook swivels

- Swivels prevent a load from twisting caused by the natural tendency for wire rope to unwind under load.
- These swivels, usually a part of the hook, are fitted with bearings to provide for rotation.
- Regular lubrication of the swivel bearings is extremely important and is normally applied by way of a grease zerk located on the swivel (Figure 11.3).

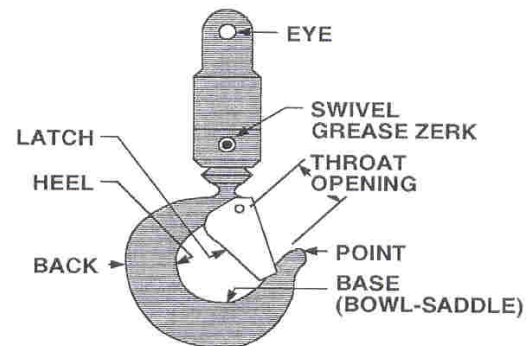

Figure 11.3: Components of a hook swivel

### 11.3 Latches

- Use a hook equipped with a latch at all times, except when a latch proves impractical or poses a danger in a particular application.
- The latch is used to retain such items as slings and chains under slack conditions.
- Hook latches, for loose sling retention, are not anti-fouling devices. They must never be allowed to support any portion of the load. Hook latches must be inspected for damage just as the hook must be inspected. Ensure the latch is in place and properly centered on the hook.
- Hook latches should never be crowded by oversized rope or stiff riggings.
- Make certain the load is properly seated on the “bowl-saddle” before a lift is attempted.

### 11.4 Load hook inspection

- Inspections and record-keeping requirements for hooks are determined by the kind of equipment the hooks are used on. When the inspection requirements for hooks are specified in regulations applicable to your equipment, those regulations will take precedence over the information presented here.
- Prior to initial use, inspect all new and repaired hooks to ensure compliance with the items listed in the hook inspection checklist below (Figure 11.4).

### HOOK INSPECTION CHECKLIST

<b>Check for:</b>	<b>Remove hook from service* if you see the following conditions:</b>
DISTORTION (Bending or twisting)	Any visible bend or twist from the plane of the unbent hook.
DISTORTION (Increased throat opening)	An increase in throat opening exceeding five percent (or as recommended by the manufacturer)
WEAR	If wear exceeds 10 percent of the original section dimension (or as recommended by the manufacturer)
CRACKS, NICKS, GOUGES	Cracks, nicks, and gouges must be repaired by a designated repair person by grinding longitudinally following the contour of the hook, provided that no dimension is reduced by more than 10 percent of its original value (or as recommended by the manufacturer). A qualified person may authorize continued use if the reduced area is not critical.
LATCH (Engagement/damage/ malfunction)	If a latch becomes inoperative because of wear or deformation, it must be replaced or repaired before being put back into service. If the latch fails to fully close the throat opening, remove the hook from service or wire it shut until repaired.
HOOK ATTACHMENTS & OTHER MEANS OF SECURING LOADS	If any indication of distortion, wear, cracks, nicks, or gouges is present, remove from service unless a qualified person authorizes their use. (Or as recommended by the manufacturer.)
*Hooks having any of the deficiencies listed shall be removed from service unless a qualified person approves their continued use and initiates corrective action. Hooks approved for continued use shall be subjected to periodic inspection.	

Figure 11.4: Hook inspection checklist



## CHAPTER 12: Rigging

This chapter presents the general criteria for the selection, inspection, and use of slings and other rigging hardware used to attach the load to the crane hook properly and ensure load stability. Rigging components include hardware (shackles, eye-bolts, etc.) and slings (wire rope, chain, synthetics).



Figure 12.1: Typical rigging components

### 12.1 General precautions

When employees are engaged in hooking, unhooking, or guiding the load, or in the initial connection of a load to a component or structure and are within the fall zone, all of the following criteria must be met:

- The materials must be rigged by a qualified rigger.
- Never exceed the Working Load Limit (WLL) for each piece of rigging. WLLs are rated for a straight vertical lift.
- Visually inspect rigging before each use. Removed from service any items meeting rejection criteria.
- Avoid shock loading.
- Slings shall be hitched so as to provide the best load control.
- Do not allow any body parts to get in between the sling and the load.
- Personnel shall not ride the sling.
- When multiple slings are used, they should be attached to the bow of the shackle and the hook to the shackle pin.
- Do not pull sling(s) from under a load when the load is resting on the sling(s).
- Synthetic slings can be used in temperatures up to 200° F.
- Slings that come in contact with abrasive surfaces and edges shall be protected with material of sufficient strength and thickness.

- The center of gravity is the central point at which the load weight would be evenly distributed to any side; this is also referred to as the balance point (Figure 12.2).

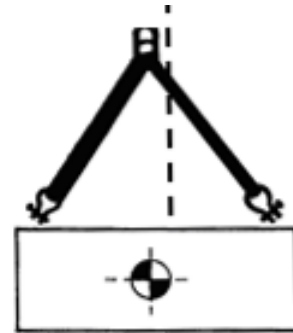

Figure 12.2: Center of gravity or balance point

- Determine a load's approximate location of the center of gravity before hoisting.
- The load must be rigged over the center of gravity (placing it directly below the load hook) or the load will shift when hoisted (Figure 12.3).

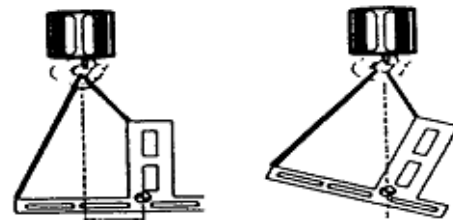

Figure 12.3: Rig load over center of gravity or load will shift when hoisted

### 12.2 Sling inspections

#### 12.2.1 Wire rope slings—causes for removal:

Remove wire rope slings from service if any of the following conditions are found:

- **Broken wires:** 5 broken wires in one strand or 10 broken wires among all strands in one rope lay
- **Metal loss:** one-third ( $\frac{1}{3}$ ) of wire's original diameter
- **Distortion:** wire is crushed or kinked
- **Heat damage:** wire shows weld marks or is burned



- Bad, deformed, or broken end attachments
- Bent hooks: see Chapter 11, Load Hooks
- Metal corroded
- Identification tag ID missing or illegible

### 12.2.2 Chain slings—causes for removal

Remove chain slings from service if any of the following conditions are found:

- Wear, nicks, cracks, breaks, gouges, stretch, bends, weld splatter, and/or discoloration from excessive temperature
- Links and attachments do not hinge freely
- Hook latches have evidence of permanent distortion or do not hinge freely
- Sling identification tag missing or illegible

### 12.2.3 Synthetic slings—causes for removal

Remove synthetic slings from service if any of the following conditions are found:

- Acid/caustic burns
- Melting or charring
- Powder is detected
- Holes, tears, cuts or snags
- Broken or worn stitching
- Excessive abrasive wear
- Knots in any part of the sling
- Cracked, distorted, or broken fittings
- Missing or illegible sling identification tag

## 12.3 Basic hitches

The type of hitch affects the load capacity rating. Following are some basic types of hitches:





<p><b>Vertical</b> or straight attachment is simply connecting a sling from a lifting hook to the load. Full rated load of the sling may be used, but never exceeded. A tag line should be used on such a lift to prevent rotation which can damage the sling.</p>	
<p><b>Choker hitches</b> reduce lifting capability of a vertical sling because this method of rigging affects the ability of the sling components to adjust during the lift, places angular loading on the body of the sling, and creates a small diameter bend in the sling body at the choke point. Provides excellent grip and load control.</p>	
<p><b>Basket hitches</b> distribute a load equally between the two legs of a sling and capacity is based on the angles at which legs are rigged to the load. When using a basket hitch, balance the load to prevent slippage.</p>	
<p><b>Bridle hitches</b> are defined as two or more slings working together and attached to the same collection point. They can be attached to the hoisting hook by means of a master link or a shackle.</p>	

Figure 12.4: Types of hitches (in order, from top)—vertical, choker, basket, and bridle



## CHAPTER 13: Winch

This chapter presents criteria, rules, and standards for using a winch with articulating cranes.

### 13.1 General information

- Every wire rope has three basic components (Figure 13.1):
  - The wires form the strands and collectively provide rope strength
  - The strands which are wound around the core
  - The core that forms a foundation for the strands; the core of IWRC (independent wire rope core) wire rope is a smaller independent wire rope
- Hoisting steel wire rope comes in various grades. The term *grade* is used to designate the nominal strength of the rope. The three hoisting rope grades are:
  - Improved Plow Steel (IPS)
  - Extra Improved Plow Steel (EIPS)
  - Extra Extra Improved Plow Steel (EEIPS)
- The grade of wire rope cannot be determined by feel or appearance. To properly evaluate a rope system, you must obtain the grade from the manufacturer or supplier.
- Wire rope will fail if worn out, overloaded, misused, damaged, or improperly maintained.

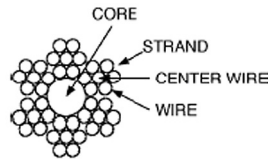

Figure 13.1: Components of wire rope

or four randomly distributed broken wires in 30 rope diameters.

- For standard wire rope: When there are either three broken wires in one strand or a total of six broken wires in all strands in any one rope lay. A *rope lay* is the axial distance along the rope in which one strand makes one complete turn around the rope.

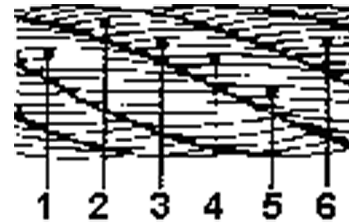

Figure 13.2: Example of six broken wires in one rope lay

- When flat spots on the outer wires appear and those outside wires are less than two-thirds the thickness of the unworn outer wire (1/3 loss).

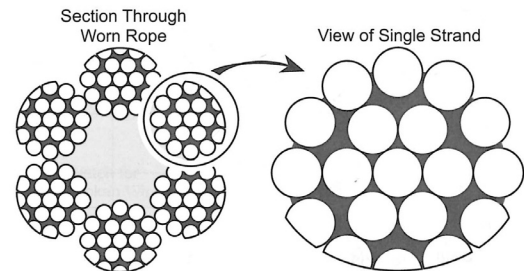

Figure 13.3: Example of flat spots on outer wires

- When there is a decrease of diameter indicating a core failure

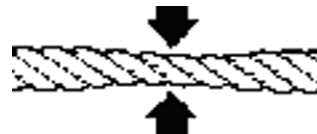

Figure 13.4: Example of decrease in diameter indicating a core failure

### 13.2 Wire rope inspection

- **Shift Inspection:** Inspect for kinking (sharp bends), crushing, unstranding, birdcaging, core protrusion, rope diameter loss, rope strand unevenness, general corrosion, broken or cut strands, heat damage, and integrity of end attachments.
- **Monthly Inspection:** Each month, inspect the entire length of the rope, the wire rope eye, and the sheaves, drums and other apparatus with which the rope makes contact.
- Corrosion can be cause for replacement. Note any corrosion developing and monitor it closely.
- Immediately remove and replace wire rope showing any of the following deficiencies:
  - For rotation-resistant wire ropes: Two randomly distributed broken wires in six rope diameters

- When kinking, crushing, bird-caging or other distortion occurs

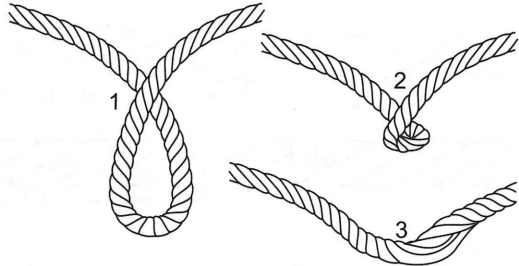

Figure 13.5: Example of kinked or crushed wire rope

- When there is noticeable heat damage (discoloration) of the rope by any means



Figure 13.6: Example of heat damage (discoloration)

- When the diameter is reduced from nominal size by 5% or more
- If a broken wire protrudes or loops out from the core of the rope.



Figure 13.7: Example of protruding wire core

### 13.3 Safety precautions for wire ropes

- Never overload a wire rope.
- Never shock load a wire rope.
- Avoid the formation of kinks.
- Do not intentionally knot wire rope.
- Do not drag wire rope over a non-rotating support such as a non-functioning sheave.
- Do not use worn, flat grooved, nicked, or otherwise broken sheaves.
- Wrap wire rope onto the drum evenly.
- Select replacement wire rope to match the original capacity and use of the crane.
- Do not expose the rope to corrosive chemicals, heat, or electrical contact.

- Lubricate the rope frequently to reduce friction and help prevent corrosion.

### 13.4 Calculating working load limit/ permissible line pull

- Divide the manufacturer's rated breaking strength (BS) by an industry design factor (DF) to determine the working load limit (WLL) for one part of the hoisting line.
- *Parts-of-Line* (POL) are defined as the number of lengths of hoisting line between the boom tip and the hoisting hook. On articulating cranes there are usually one or two POLs.
- Wire rope design factors (DF):
  - Standard wire rope is 3.5 to one (3.5:1)
  - Rotation-resistant wire rope is 5.0 to one (5:1)
- BS divided by DF equals WLL per POL; for example: 9/16" wire rope (6x19 IPS) with nominal 35,000 lb. (BS) ÷ 3.5 (DF) = 10,000 lb. WLL
  - For one POL = 10,000 lb. wire rope capacity
  - For two POL = 20,000 lb. wire rope capacity
- There must be no less than two full wraps of wire rope on the drum at all times.
- Verify that the wire rope is seated tightly on the drum prior to operation; slack in the hoisting wire rope can cause the wire rope on the drum to unspool.
- The drum flange must extend ½" or more above the top layer of the wire rope.

### 13.5 Thimble attachment

When attaching a thimble to a winch wire rope (Figure 13.9), proceed as follows:

1. Note that the base of the clip is applied to the live end of the rope and the U-bolt is applied to the dead end.
2. Attach the first clip so the U-bolt is no less than the clip base width from the dead end of the rope.
3. Attach the second clip as near the loop as possible.
4. Use specifications in Figure 13.10 when fabricating a thimble.

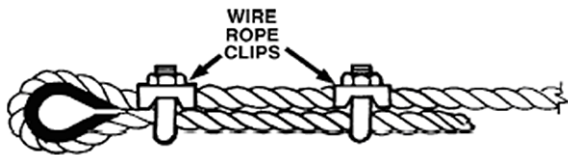

Figure 13.8: Thimble attachment to winch wire rope

### 13.6 Wedge socket attachment

- **Caution:** The efficiency rating of a wedge socket is 70 percent of the breaking strength of the wire rope.
- Crimping effect of wedge sockets can reduce the working load limit of a line by as much as 30 percent.
- When attaching a wedge socket, use one of the approved methods shown in Figure 13.11.

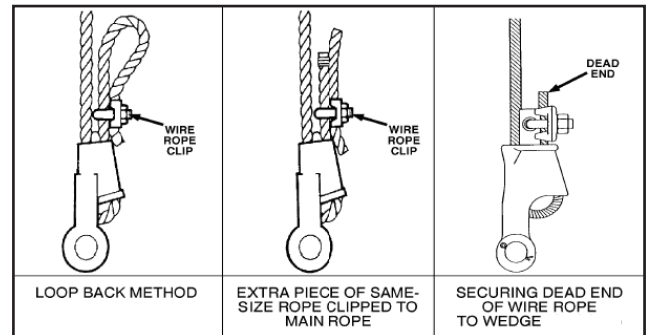

Figure 13.10: Approved methods for attaching a wedge socket

### WIRE ROPE THIMBLE SPECIFICATIONS

WIRE ROPE DIAMETER (in.)	MINIMUM # OF CLIPS	AMOUNT OF ROPE TO TURN BACK (in.)	SPACE BETWEEN CLIPS (in.)	TORQUE (ft.-lbs.)
1/4"	2	4¾"	3¼"	15
5/16"	2	5¼"	3¼"	30

Figure 13.9: Specifications for two sizes of thimble

This page intentionally left blank



**NCCCO ARTICULATING CRANE REFERENCE MANUAL**

**APPENDICES**

- **Appendix A: ACCNA Crane Inspection Checklist**
- **Appendix B: Standard Hand Signals for Articulating Crane Operations**
- **Appendix C: Sample Articulating Crane Load Charts**

This page intentionally left blank



# Appendix A: ACCNA Crane Inspection Checklist

USE OF THIS CHECKLIST IS SUBJECT TO TERMS, CONDITIONS, NOTICES AND DISCLAIMERS OF WARRANTY ATTACHED HERETO. ADDITIONAL COPIES MAY BE OBTAINED BY CALLING 1(800)441-NTEA, OR AT [WWW.NTEA.COM](http://WWW.NTEA.COM).

## *Inspection Checklist* ARTICULATING BOOM CRANES

**1** REV: JUNE 2012

OWNER/COMPANY
CONTACT PERSON
CRANE MAKE & MODEL
CRANE SERIAL NUMBER
UNIT I.D. NUMBER
LOCATION OF UNIT

TYPE OF INSPECTION (check one) <input type="checkbox"/> DAILY (if deficiency found) <input type="checkbox"/> QUARTERLY <input type="checkbox"/> MONTHLY <input type="checkbox"/> ANNUAL
DATE INSPECTED
HOUR METER READING (if applicable)
INSPECTED BY (print)
SIGNATURE OF INSPECTOR

**TYPE OF INSPECTION**

*NOTES:*

Daily and monthly inspections are to be performed by a “competent person”, who is capable of identifying existing and predictable hazards in the surroundings or working conditions which are unsanitary, hazardous, or dangerous to employees, and who has authorization to take prompt corrective measures to eliminate them.

Quarterly and annual inspections are to be performed by a “qualified person” who, by possession of a recognized degree, certificate, or professional standing, or who by extensive knowledge, training and experience, successfully demonstrated the ability to solve/resolve problems relating to the subject matter, the work, or the project.

One hour of normal crane operation assumes 20 complete cycles per hour. If operation exceeds 20 cycles per hour, inspection frequency should be increased accordingly.

Consult Operator / Service Manual for additional inspection items, service bulletins and other information.

Before inspecting and operating crane, crane must be set up away from power lines and leveled with stabilizers deployed according to the crane manufacturer's directions.

**DAILY (D):** Before each shift of operation, those items designated with a **(D)** must be inspected.

**MONTHLY (M):** Monthly inspections or 100 hours of normal operation (which ever comes first) includes all daily inspections plus items designated with an **(M)**. This inspection must be recorded and retained for a minimum of 3 months.

**QUARTERLY (Q):** Every three months or 300 hours of normal operation (which ever comes first) includes all daily and monthly inspection items plus items designated with a **(Q)**. This inspection must be documented, maintained, and retained for a minimum of 12 months, by the employer that conducts the inspection.

**ANNUAL (A):** Each year or 1200 hours of normal operation (which ever comes first) includes all items on this form which encompasses daily, monthly and quarterly inspections plus those items designated by **(A)**. This inspection must be documented, maintained, and retained for a minimum of 12 months, by the employer that conducts the inspection.

# Appendix A: ACCNA Crane Inspection Checklist

## Inspection Checklist

## ARTICULATING BOOM CRANES

2

FREQUENCY	ITEM	KEY	✓ = SATISFACTORY ✗ = DEFICIENCY (an immediate determination must be made as to whether the deficiency constitutes a safety hazard and must be corrected prior to operation)	R = RECOMMENDATION (should be considered for corrective action)	NA = NOT APPLICABLE	STATUS ✓, ✗ R, NA
			INSPECTION DESCRIPTION			
D	1	Labels	All load charts, safety & warning labels, & control labels are present and legible.			
D	2	Controls	Control mechanisms for proper operation of all functions, leaks & cracks.			
D	3	Station	Control and operator's station for dirt, contamination by lubricants, & foreign materials.			
D	4	Hyd System	Hydraulic system (hoses, tubes & fittings) for leakage & proper oil level.			
D	5	Hook	Presence & proper operation of hook safety latches.			
D	6	Wire Rope	Inspect for apparent deficiencies per applicable requirements and manufacturer's specifications			
D	7	Pins	Proper engagement of all connecting pins & pin retaining devices.			
D	8	General	Overall observation of crane for damaged or missing parts, cracked welds & presence of safety covers.			
D	9	Operation	During operation, observe crane for abnormal performance, unusual wear (loose pins, wire rope damage, etc.). If observed, discontinue use & determine cause & severity of hazard.			
D	10	Remote Ctrls	Operate remote control devices to check for proper operation.			
D	11	Electrical	Operate all lights, alarms, etc. to check for proper operation.			
D	12	Anti Two-Blocking or Two Block Damage Prevention	Operate anti Two-blocking device or Two Block Damage Prevention to check for proper operation.			
D	13	Tires	Check tires (when in use) for proper inflation and condition.			
D	14	Ground Conditions	Ground conditions around the equipment for proper support, including ground settling under and around stabilizers and supporting foundations, ground water accumulation, or similar conditions			
D	15	Level Position	The equipment for level position within the tolerances specified by the equipment manufacturer's recommendations, both before each shift and after each move and setup.			
D	16	Operator cab windows	significant cracks, breaks, or other deficiencies that would hamper the operator's view.			
D	17	Rails, rail stops, rail clamps and supporting surfaces	Rails, rail stops, rail clamps and supporting surfaces when the equipment has rail traveling.			
D	18	Safety devices	Safety devices and operational aids for presence and proper operation.			
D	19	Safety devices	Stabilizer positioning indicators are present, clear, and visible.			
D	20	Electrical	Electrical apparatus for malfunctioning, signs of apparent excessive deterioration, dirt or moisture accumulation.			
D	21		Other			
D	22		Other			
M	23	Daily	All daily inspection items.			
	24	Cylinders	M Visual inspection of cylinders for leakage at rod, fittings & welds. Damage to rod & case.			
M	25	Valves	Holding valves for proper operation.			
M	26	Valves	Control valve for leaks at fittings & between sections.			
M	27	Valves	Control valve linkages for wear, smoothness of operation & tightness of fasteners. Relief valve for proper pressure settings.			
M	28	General	Bent, broken or significantly rusted/corroded parts.			
M	29	Electrical	Electrical apparatus for malfunctioning, signs of apparent excessive deterioration, dirt or moisture accumulation. Electrical systems for presence of dirt, moisture & frayed wires.			
M	30	Structure	All structural members for damage.			
M	31	Welds	All welds for breaks & cracks.			
M	32	Pins	All pins for proper installation & condition.			
M	33	Hardware	All bolts, fasteners & retaining rings for tightness, wear & corrosion			
M	34	Wear	Pads Condition of wear pads.			
M	35	Pump & Motor	Hydraulic pumps & motors for leakage at fittings, seals & between sections. Check tightness of mounting bolts.			
M	36	PTO	Transmission/PTO for leakage, abnormal vibration & noise, alignment & mounting bolt torque.			
M	37	Hyd Fluid	Quality of hydraulic fluid and for presence of water.			
M	38	Hyd Lines	Hoses & tubes for leakage, abrasion damage, blistering, cracking, deterioration, fitting leakage & secured properly.			
M	39	Hook	Load hook for abnormal throat distance, twist, wear & cracks.			
M	40	Wire Rope	Condition of load line.			
M	41	Manual	Presence of operator's manuals with unit.			
M	42		Other			
M	43		Other			

# Appendix A: ACCNA Crane Inspection Checklist

## Inspection Checklist

## ARTICULATING BOOM CRANES

3





FREQUENCY	ITEM	KEY	√ = SATISFACTORY	R = RECOMMENDATION	STATUS √, X R, NA
			X = DEFICIENCY (an immediate determination must be made as to whether the deficiency constitutes a safety hazard and must be corrected prior to operation)	(should be considered for corrective action)	
INSPECTION DESCRIPTION					
Q	44	Daily	All daily inspection items.		
Q	45	Monthly	All monthly inspection items.		
Q	46	Rotation Sys	Rotation bearing for proper torque of all mounting bolts.		
Q	47	Hardware	Base mounting bolts for proper torque.		
Q	48	Structure	All structural members for deformation, cracks & corrosion.		
	49		Base		
	50		Stabilizer beams & legs		
	51		Mast		
	52		Inner boom		
	53		Outer boom		
	54		Extension(s)		
	55		Jib boom		
	56		Jib extension(s)		
	57		Other		
Q	58	Hardware	Pins, bearings, shafts, gears, rollers, & locking devices for wear, cracks, corrosion & distortion.		
	59		Rotation bearing(s)		
	60		Inner boom pivot pin(s) & retainer(s)		
	61		Outer boom pivot pin(s) & retainer(s)		
	62		Inner boom cylinder pin(s) & retainer(s)		
	63		Outer boom cylinder pin(s) & retainer(s)		
	64		Extension cylinder pin(s) & retainer(s)		
	65		Jib boom pin(s) & retainer(s)		
	66		Jib cylinder pin(s) & retainer(s)		
	67		Jib extension cylinder pin(s) & retainer(s)		
	68		Boom tip attachments		
	69		Other		
Q	70	Hyd Lines	Hoses, fittings & tubing for proper routing, leakage, blistering, deformation & excessive abrasion.		
	71		Pressure line(s) from pump to control valve		
	72		Return line(s) from control valve to reservoir		
	73		Suction line(s) from reservoir to pump		
	74		Pressure line(s) from control valve to each function		
	75		Load holding valve pipe(s) and hose(s)		
	76		Other		
Q	77	Pumps & motors	Pumps & Motors for loose bolts/fasteners, leaks, noise, vibration, loss of performance, heating & excess pressure.		
	78		Winch motor(s)		
	79		Rotation motor(s)		
	80		Other		
Q	81	Valves	Hydraulic valves for cracks, spool return to neutral, sticking spools, relief valve failure.		
	82		Main control valve		
	83		Load holding valve(s)		
	84		Stabilizer or auxiliary control valve(s)		
	85		Other		
	86		Other		
Q	87	Cylinders	Hydraulic cylinders for drifting, rod seal leakage & leakage at welds. Rods for nicks, scores & dents. Case for damage. Case & rod ends for damage & abnormal wear.		
	88		Stabilizer cylinder(s)		
	89		Inner boom cylinder(s)		
	90		Outer boom cylinder(s)		
	91		Extension cylinder(s)		
	92		Rotation cylinder(s)		
	93		Jib lift cylinder(s)		
	94		Jib extension cylinder(s)		
	95		Other		
Q	96	Winch	Winch, sheaves & drums for damage, abnormal wear, abrasions & other irregularities.		
Q	97	Hyd Filters	Hydraulic filters for replacement per maintenance schedule.		





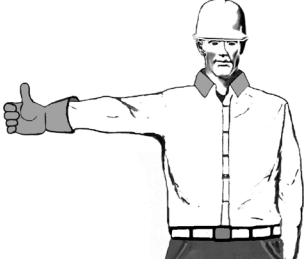
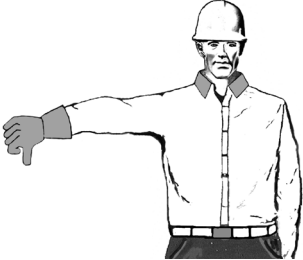

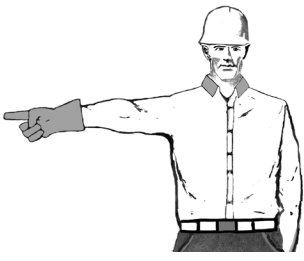
## Appendix B: Standard Hand Signals FOR ARTICULATING CRANE OPERATIONS

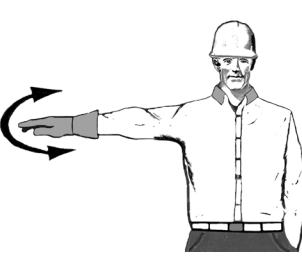
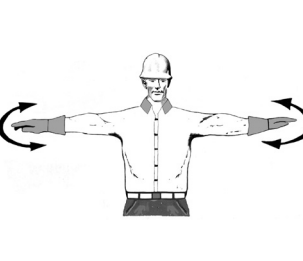
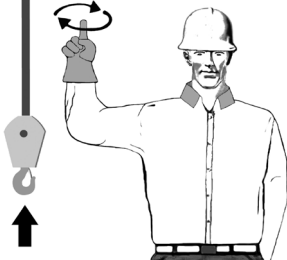
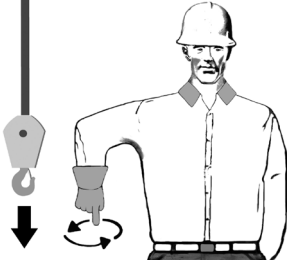
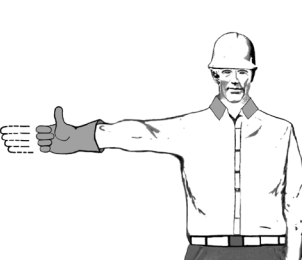
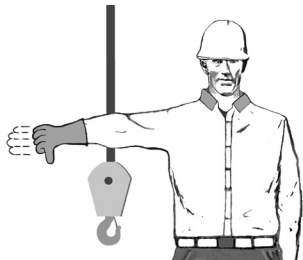
 <p><b>RAISE BOOM TIP VERTICALLY</b> Arm extended, fingers closed, thumb pointed upward.</p>	 <p><b>LOWER BOOM TIP VERTICALLY</b> Arm extended, fingers closed, thumb pointed downward.</p>	 <p><b>INCREASE RADIUS OF BOOM TIP</b> Both fists in front of body with thumbs pointing outward.</p>	 <p><b>DECREASE RADIUS OF BOOM TIP</b> Both fists in front of body with thumbs pointing toward each other.</p>
 <p><b>SWING</b> Arm extended, point with finger in direction of swing of boom.</p>	 <p><b>MOVE SLOWLY</b> Use one hand to give any motion signal and place other hand motionless in front of hand giving the motion signal. (Hoist slowly shown as example.)</p>	 <p><b>STOP</b> Arm extended, palm down, move arm back and forth horizontally.</p>	 <p><b>EMERGENCY STOP</b> Both arms extended, palms down, move arms back and forth.</p>
 <p><b>HOIST LOADLINE</b> With forearm vertical, forefinger pointing up, move hand in small horizontal circle.</p>	 <p><b>LOWER LOADLINE</b> With arm extended downward, forefinger pointing down, move hand in small horizontal circle.</p>	 <p><b>RAISE THE BOOM TIP AND LOWER THE LOAD</b> With arm extended, thumb pointing up; flex fingers in and out and long as load movement is desired.</p>	 <p><b>LOWER THE BOOM TIP AND RAISE THE LOAD</b> With arm extended, thumb pointing down; flex fingers in and out and long as load movement is desired.</p>

© 2012 National Commission for the Certification of Crane Operators. All rights reserved.



## Appendix C: NCCCO Load Charts FOR ARTICULATING CRANES AND LOADERS

The following NCCCO load charts have been included—in cooperation with crane manufacturers—to help candidates prepare for the NCCCO Articulating Crane Operator Written Examination.

***THE LOAD CHARTS CONTAINED HEREIN ARE NOT TO BE USED FOR ACTUAL CRANE OPERATION AND ARE FOR TESTING PURPOSES ONLY.*** If you need a crane load chart for a specific crane, you should contact the relevant manufacturer or an authorized dealer/distributor.

In some cases only excerpts of the load charts have been included.

The National Commission for the Certification of Crane Operators would like to thank the following crane manufacturers, who have provided the time and resources necessary to create this manual:

- Cargotec USA Inc., Hiab
- Effer
- Fassi
- Iowa Mold Tooling
- Manitowoc
- Palfinger North America
- PM North America

For further information about the NCCCO Articulating Crane Operator Written Examination, please consult the NCCCO website at [www.nccco.org](http://www.nccco.org) or email [info@nccco.org](mailto:info@nccco.org) to request an *Articulating Crane Operator Candidate Handbook*.









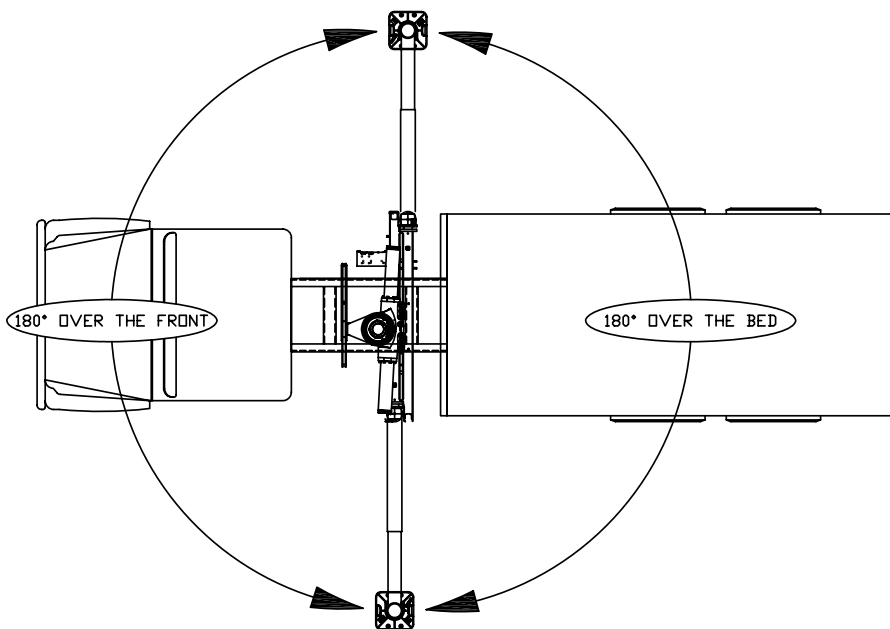
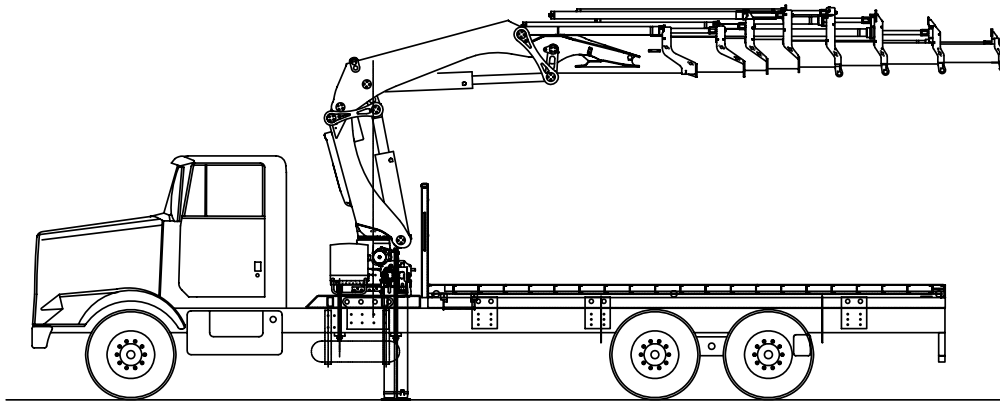

This page intentionally left blank

# Crane A









## ARTICULATING BOOM CRANE



**180° OVER THE BED**

									ft
15'1"	20'4"	26'3"	32'6"	39'1"	45'11"	53'2"	60'8"		
13600	9500	6800	5200	4100	3300	2800	2400		lbs

**180° OVER THE FRONT**

									ft
15'1"	20'4"	26'3"	32'6"	39'1"	45'11"	53'2"	60'8"		
5500	3800	2700	2100	1600	1300	1100	900		lbs

# Crane B

## ARTICULATING BOOM CRANE

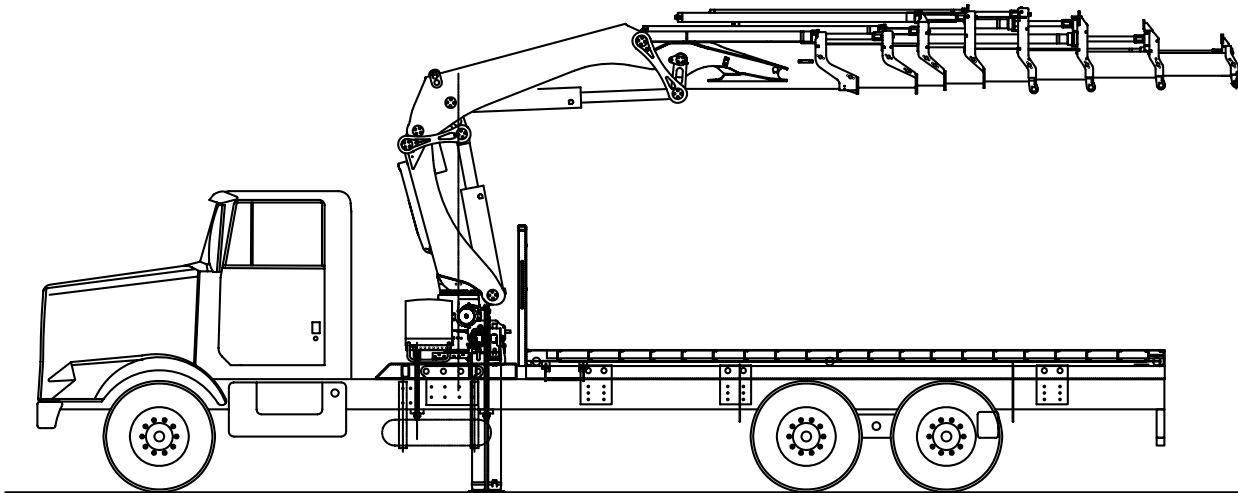

### STABILIZERS - FULLY EXTENDED

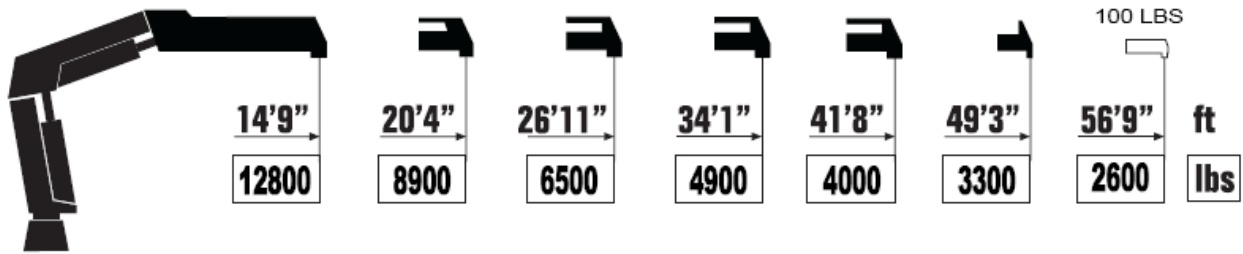

### STABILIZERS - MID SPAN

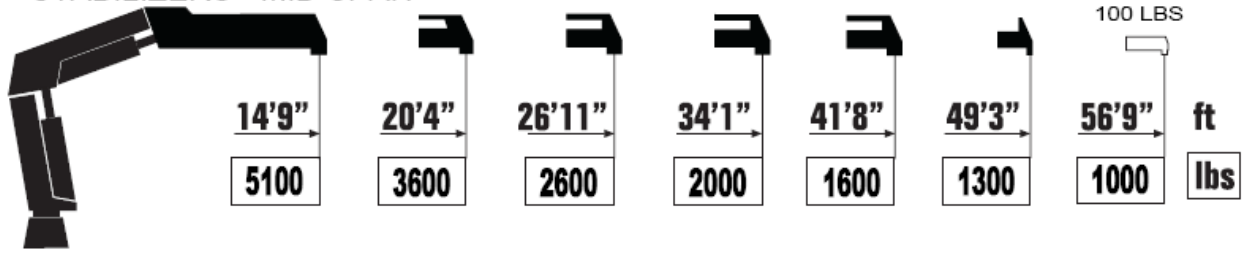

# Crane C

## ARTICULATING BOOM LOADER

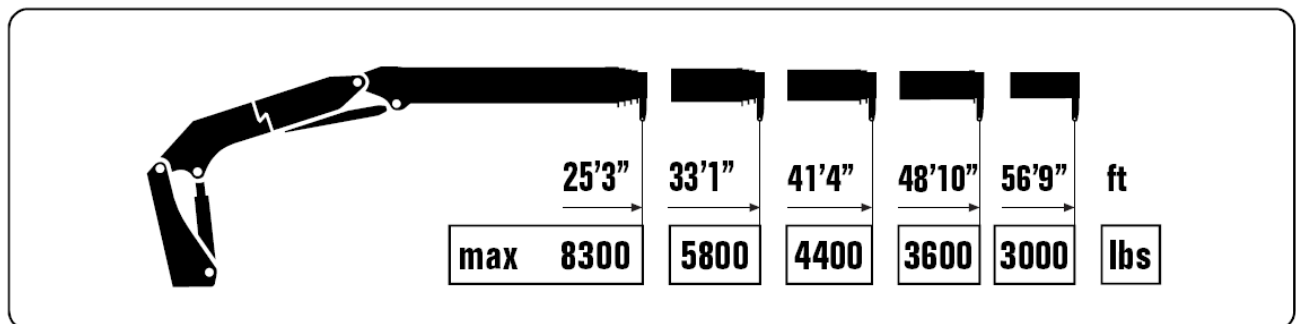
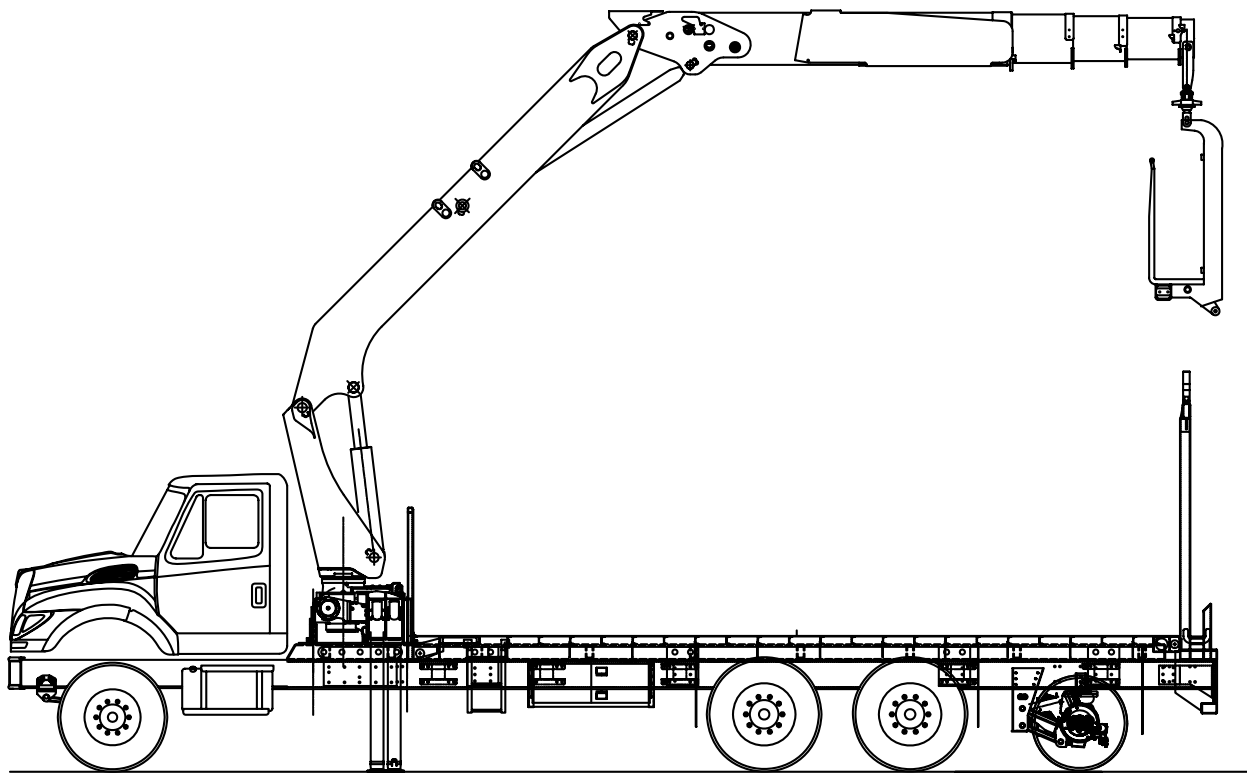

# Crane D

## ARTICULATING BOOM CRANE

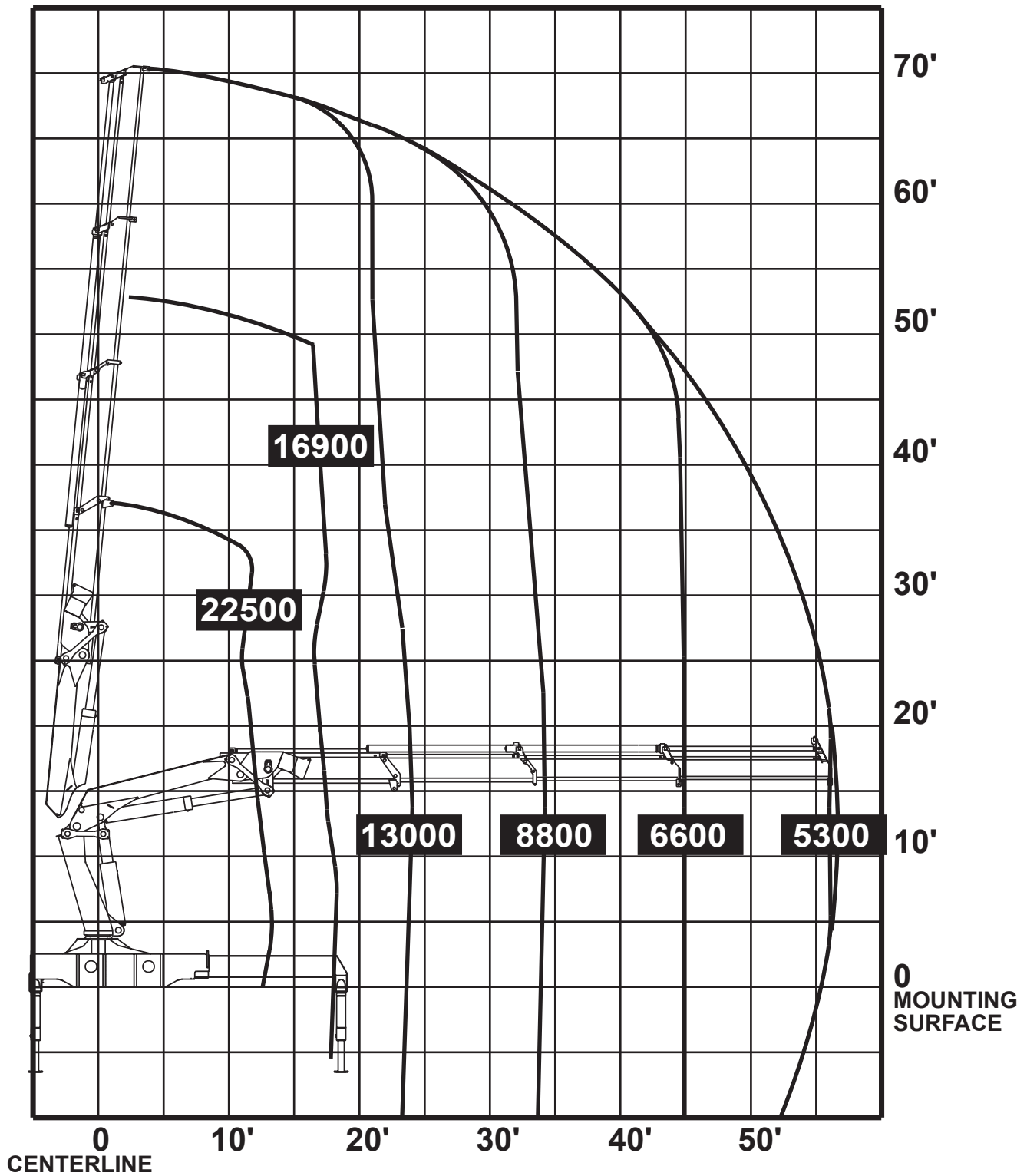

# Crane E

## ARTICULATING BOOM CRANE

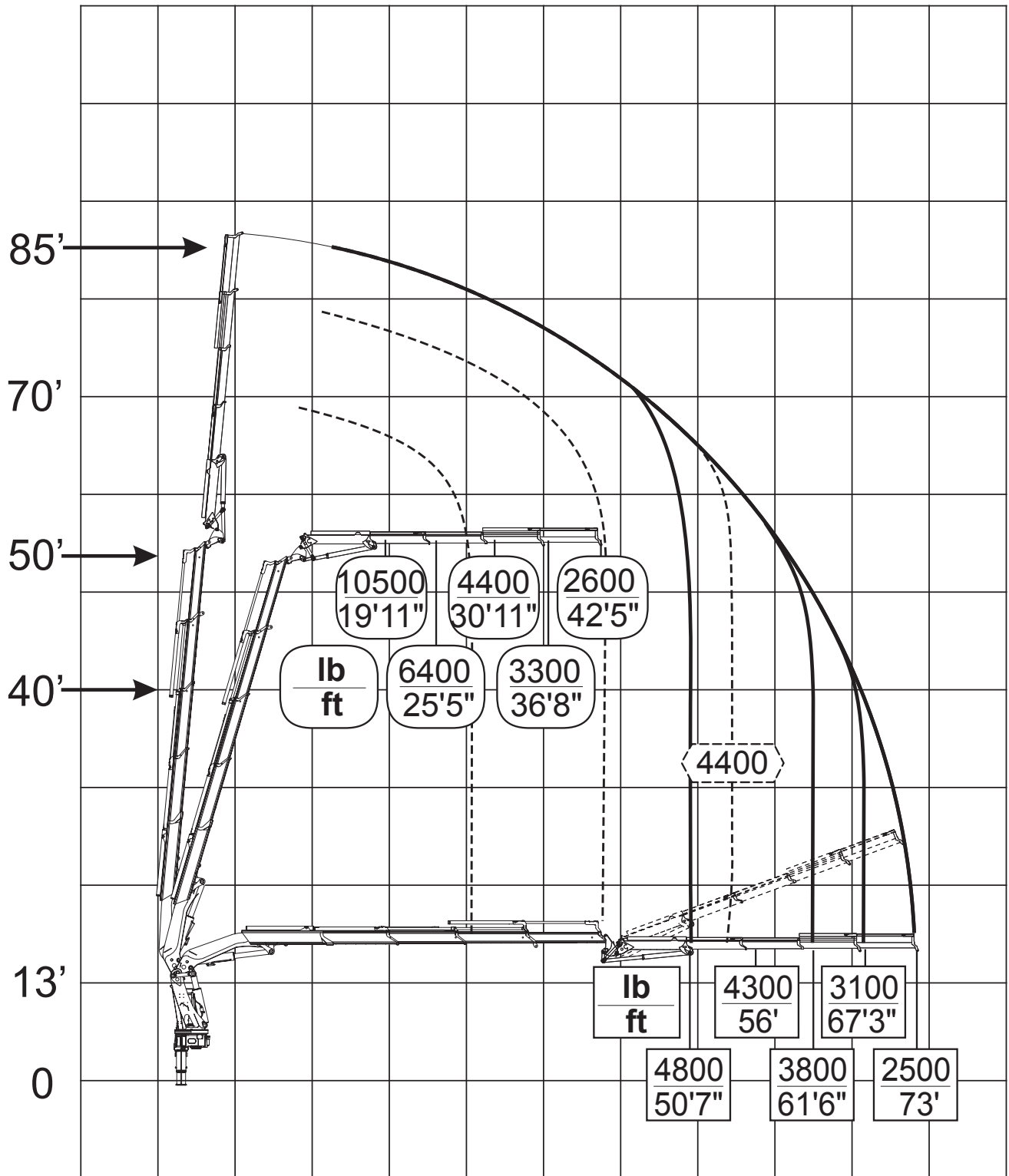

# Crane F

## ARTICULATING BOOM LOADER

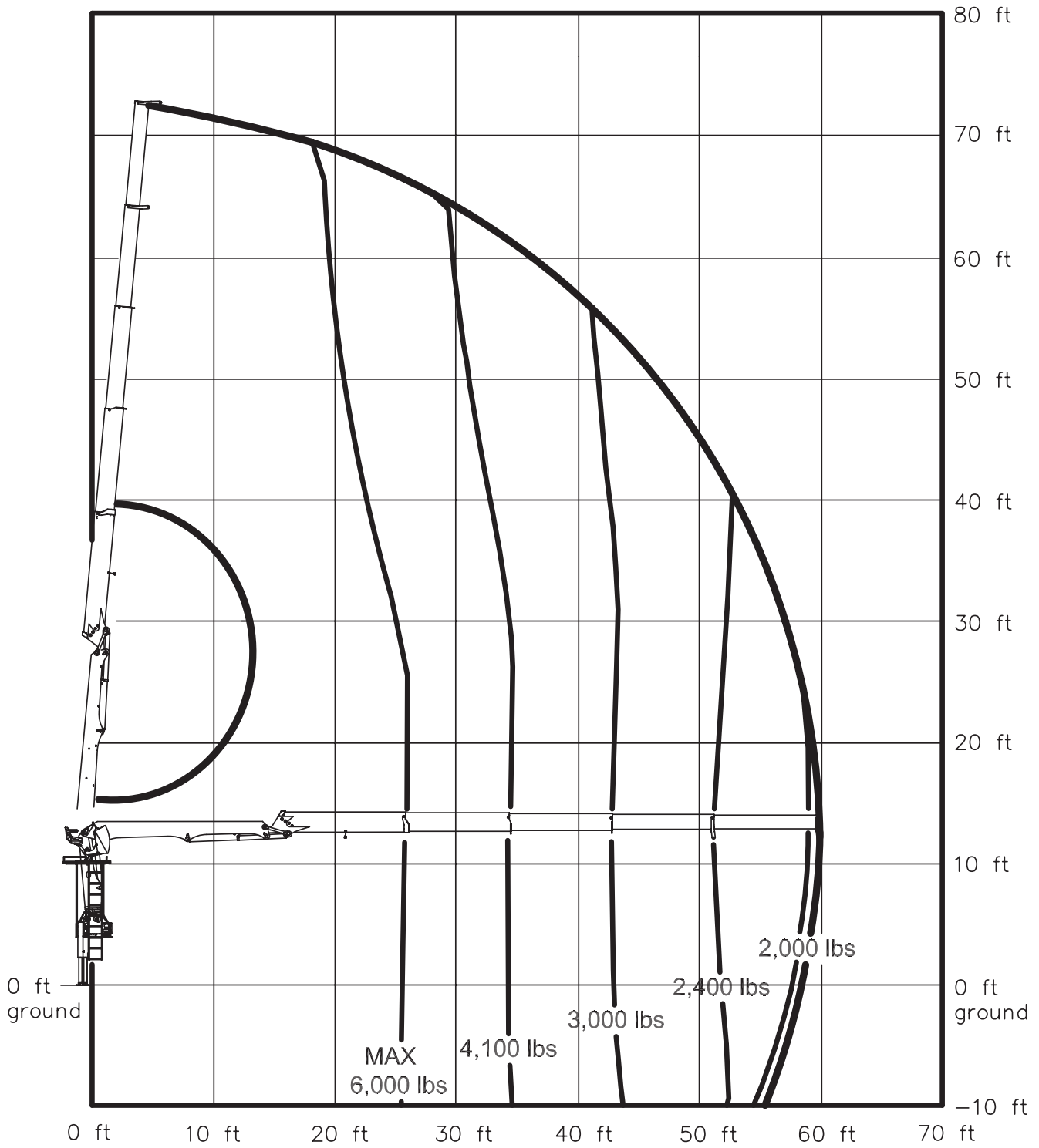

# Crane G

## ARTICULATING BOOM LOADER

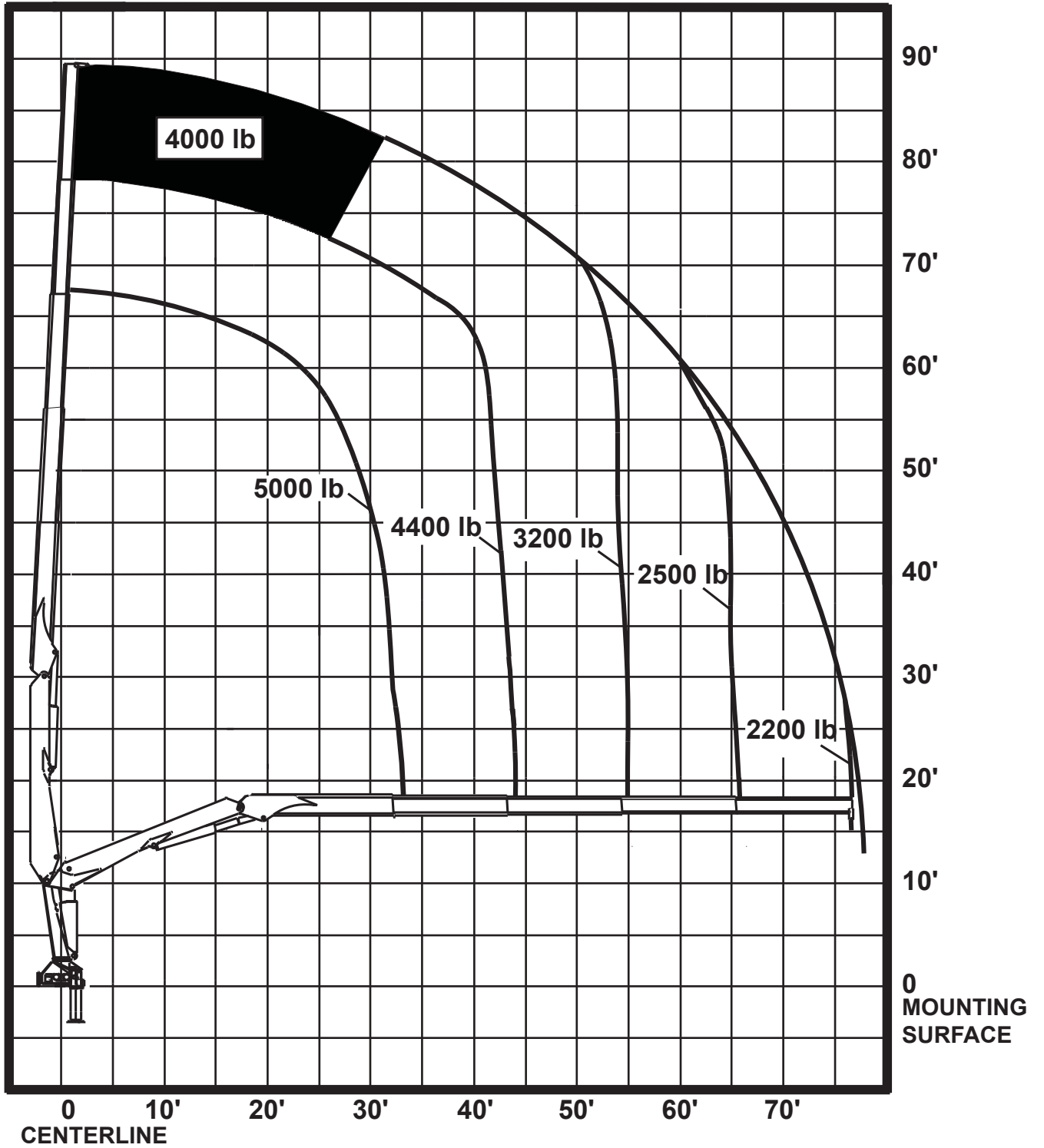



This page intentionally left blank

## IMPORTANT CONTACT INFORMATION



### **NATIONAL COMMISSION FOR THE CERTIFICATION OF CRANE OPERATORS**

2750 Prosperity Avenue, Suite 505  
Fairfax, VA 22031-4312

Phone: 703-560-2391

Fax: 703-560-2392

Email: [info@nccco.org](mailto:info@nccco.org)



**NATIONAL COMMISSION FOR THE  
CERTIFICATION OF CRANE OPERATORS**

2750 Prosperity Avenue, Suite 505  
Fairfax, VA 22031-4312

Phone: 703-560-2391

Fax: 703-560-2392

[info@nccco.org](mailto:info@nccco.org)

[www.nccco.org](http://www.nccco.org)